

Thyristor Module

$$V_{RRM} = 2 \times 1200 \text{ V}$$

$$I_{TAV} = 60 \text{ A}$$

$$V_T = 1.24 \text{ V}$$

Phase leg

Part number

MCC56-12io1B

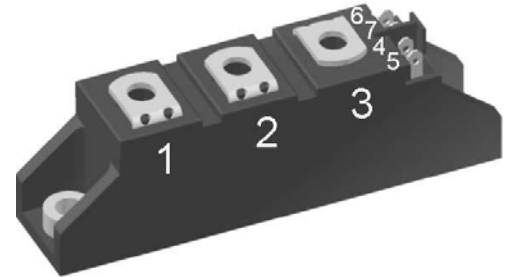

Backside: isolated



Features / Advantages:

- Thyristor for line frequency
- Planar passivated chip
- Long-term stability
- Direct Copper Bonded Al₂O₃-ceramic

Applications:

- Line rectifying 50/60 Hz
- Softstart AC motor control
- DC Motor control
- Power converter
- AC power control
- Lighting and temperature control

Package: TO-240AA

- Isolation Voltage: 3600 V~
- Industry standard outline
- RoHS compliant
- Soldering pins for PCB mounting
- Base plate: DCB ceramic
- Reduced weight
- Advanced power cycling

| Thyristor | | | Ratings | | | |
|----------------|--|--|---------------------------|------|------|-------------------|
| Symbol | Definition | Conditions | min. | typ. | max. | Unit |
| $V_{RSM/DSM}$ | max. non-repetitive reverse/forward blocking voltage | $T_{VJ} = 25^{\circ}C$ | | | 1300 | V |
| $V_{RRM/DRM}$ | max. repetitive reverse/forward blocking voltage | $T_{VJ} = 25^{\circ}C$ | | | 1200 | V |
| I_{RD} | reverse current, drain current | $V_{R/D} = 1200 V$ | $T_{VJ} = 25^{\circ}C$ | | 200 | μA |
| | | $V_{R/D} = 1200 V$ | $T_{VJ} = 125^{\circ}C$ | | 5 | mA |
| V_T | forward voltage drop | $I_T = 100 A$ | $T_{VJ} = 25^{\circ}C$ | | 1.26 | V |
| | | $I_T = 200 A$ | | | 1.57 | V |
| | | $I_T = 100 A$ | $T_{VJ} = 125^{\circ}C$ | | 1.24 | V |
| | | $I_T = 200 A$ | | | 1.62 | V |
| I_{TAV} | average forward current | $T_C = 85^{\circ}C$ | $T_{VJ} = 125^{\circ}C$ | | 60 | A |
| $I_{T(RMS)}$ | RMS forward current | 180° sine | | | 100 | A |
| V_{T0} | threshold voltage | } for power loss calculation only | $T_{VJ} = 125^{\circ}C$ | | 0.85 | V |
| r_T | slope resistance | | | | 3.7 | m Ω |
| R_{thJC} | thermal resistance junction to case | | | | 0.45 | K/W |
| R_{thCH} | thermal resistance case to heatsink | | | 0.20 | | K/W |
| P_{tot} | total power dissipation | | $T_C = 25^{\circ}C$ | | 222 | W |
| I_{TSM} | max. forward surge current | $t = 10 \text{ ms}; (50 \text{ Hz}), \text{ sine}$ | $T_{VJ} = 45^{\circ}C$ | | 1.50 | kA |
| | | $t = 8,3 \text{ ms}; (60 \text{ Hz}), \text{ sine}$ | $V_R = 0 V$ | | 1.62 | kA |
| | | $t = 10 \text{ ms}; (50 \text{ Hz}), \text{ sine}$ | $T_{VJ} = 125^{\circ}C$ | | 1.28 | kA |
| | | $t = 8,3 \text{ ms}; (60 \text{ Hz}), \text{ sine}$ | $V_R = 0 V$ | | 1.38 | kA |
| I^2t | value for fusing | $t = 10 \text{ ms}; (50 \text{ Hz}), \text{ sine}$ | $T_{VJ} = 45^{\circ}C$ | | 11.3 | kA ² s |
| | | $t = 8,3 \text{ ms}; (60 \text{ Hz}), \text{ sine}$ | $V_R = 0 V$ | | 10.9 | kA ² s |
| | | $t = 10 \text{ ms}; (50 \text{ Hz}), \text{ sine}$ | $T_{VJ} = 125^{\circ}C$ | | 8.13 | kA ² s |
| | | $t = 8,3 \text{ ms}; (60 \text{ Hz}), \text{ sine}$ | $V_R = 0 V$ | | 7.87 | kA ² s |
| C_J | junction capacitance | $V_R = 400 V \quad f = 1 \text{ MHz}$ | $T_{VJ} = 25^{\circ}C$ | | 74 | pF |
| P_{GM} | max. gate power dissipation | $t_p = 30 \mu s$ | $T_C = 125^{\circ}C$ | | 10 | W |
| | | $t_p = 300 \mu s$ | | | 5 | W |
| P_{GAV} | average gate power dissipation | | | | 0.5 | W |
| $(di/dt)_{cr}$ | critical rate of rise of current | $T_{VJ} = 125^{\circ}C; f = 50 \text{ Hz}$ | repetitive, $I_T = 150 A$ | | 150 | A/ μs |
| | | $t_p = 200 \mu s; di_G/dt = 0.45 A/\mu s;$ $I_G = 0.45 A; V_D = \frac{2}{3} V_{DRM}$ | non-repet., $I_T = 60 A$ | | 500 | A/ μs |
| $(dv/dt)_{cr}$ | critical rate of rise of voltage | $V_D = \frac{2}{3} V_{DRM}$ $R_{GK} = \infty; \text{ method 1 (linear voltage rise)}$ | $T_{VJ} = 125^{\circ}C$ | | 1000 | V/ μs |
| V_{GT} | gate trigger voltage | $V_D = 6 V$ | $T_{VJ} = 25^{\circ}C$ | | 1.5 | V |
| | | | $T_{VJ} = -40^{\circ}C$ | | 1.6 | V |
| I_{GT} | gate trigger current | $V_D = 6 V$ | $T_{VJ} = 25^{\circ}C$ | | 100 | mA |
| | | | $T_{VJ} = -40^{\circ}C$ | | 200 | mA |
| V_{GD} | gate non-trigger voltage | $V_D = \frac{2}{3} V_{DRM}$ | $T_{VJ} = 125^{\circ}C$ | | 0.2 | V |
| I_{GD} | gate non-trigger current | | | | 10 | mA |
| I_L | latching current | $t_p = 10 \mu s$ | $T_{VJ} = 25^{\circ}C$ | | 450 | mA |
| | | $I_G = 0.45 A; di_G/dt = 0.45 A/\mu s$ | | | | |
| I_H | holding current | $V_D = 6 V \quad R_{GK} = \infty$ | $T_{VJ} = 25^{\circ}C$ | | 200 | mA |
| t_{gd} | gate controlled delay time | $V_D = \frac{1}{2} V_{DRM}$ | $T_{VJ} = 25^{\circ}C$ | | 2 | μs |
| | | $I_G = 0.45 A; di_G/dt = 0.45 A/\mu s$ | | | | |
| t_q | turn-off time | $V_R = 100 V; I_T = 150 A; V_D = \frac{2}{3} V_{DRM}$ $di/dt = 10 A/\mu s; dv/dt = 20 V/\mu s; t_p = 200 \mu s$ | $T_{VJ} = 125^{\circ}C$ | | 150 | μs |

| Package TO-240AA | | | | Ratings | | |
|------------------|--|----------------------|-------------------------------------|---------|------|------|
| Symbol | Definition | Conditions | min. | typ. | max. | Unit |
| I_{RMS} | RMS current | per terminal | | | 200 | A |
| T_{VJ} | virtual junction temperature | | -40 | | 125 | °C |
| T_{op} | operation temperature | | -40 | | 100 | °C |
| T_{stg} | storage temperature | | -40 | | 125 | °C |
| Weight | | | | | 90 | g |
| M_D | mounting torque | | 2.5 | | 4 | Nm |
| M_T | terminal torque | | 2.5 | | 4 | Nm |
| $d_{Spp/App}$ | creepage distance on surface striking distance through air | terminal to terminal | 13.0 | 9.7 | | mm |
| $d_{Spb/Apb}$ | | terminal to backside | 16.0 | 16.0 | | mm |
| V_{ISOL} | isolation voltage | t = 1 second | | 3600 | | V |
| | | t = 1 minute | 50/60 Hz, RMS; $I_{ISOL} \leq 1$ mA | 3000 | | V |

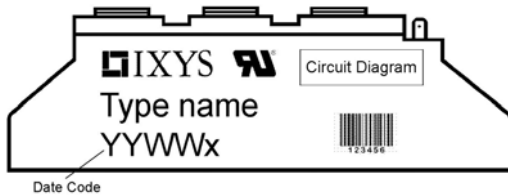

| Ordering | Part Number | Marking on Product | Delivery Mode | Quantity | Code No. |
|----------|--------------|--------------------|---------------|----------|----------|
| Standard | MCC56-12io1B | MCC56-12io1B | Box | 6 | 452742 |

| Similar Part | Package | Voltage class |
|---------------|-------------|---------------|
| MCMA65P1200TA | TO-240AA-1B | 1200 |
| MCMA85P1200TA | TO-240AA-1B | 1200 |

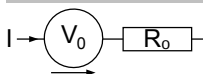
Equivalent Circuits for Simulation
** on die level*
 $T_{VJ} = 125\text{ °C}$

Thyristor

| | | | |
|--------------|--------------------|------|----|
| $V_{0\ max}$ | threshold voltage | 0.85 | V |
| $R_{0\ max}$ | slope resistance * | 2.5 | mΩ |

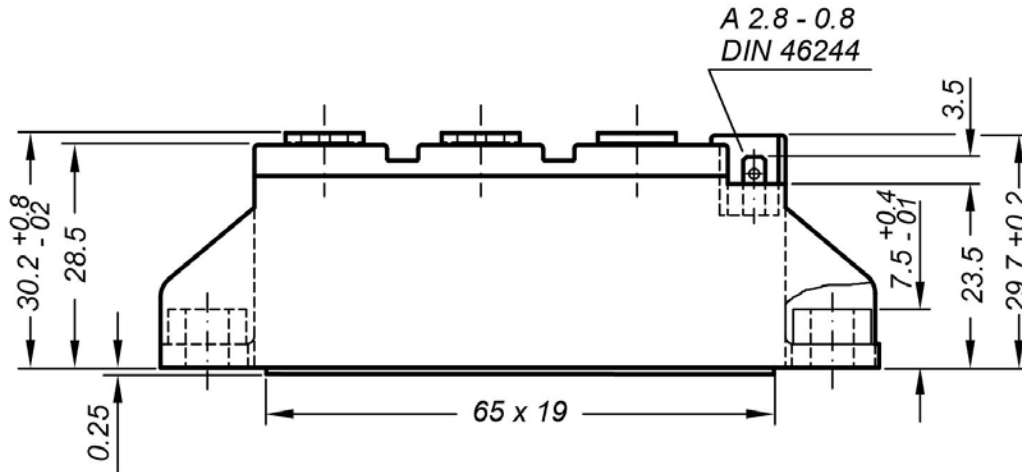
Outlines TO-240AA

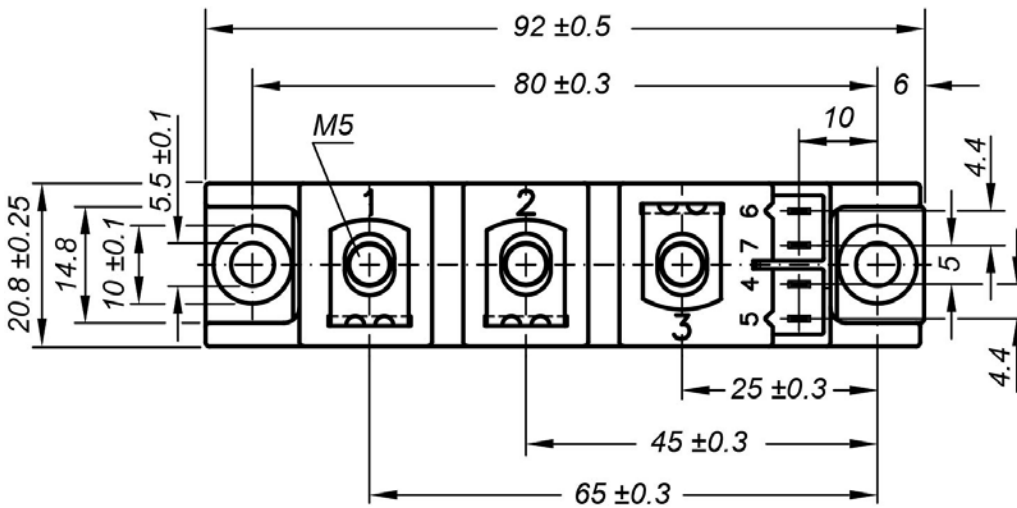

General tolerance: DIN ISO 2768 class „c“



Optional accessories: Keyed gate/cathode twin plugs
 Wire length: 350 mm, gate = white, cathode = red
 UL 758, style 3751
 Type **ZY 200L** (L = Left for pin pair 4/5)
 Type **ZY 200R** (R = Right for pin pair 6/7)



Thyristor

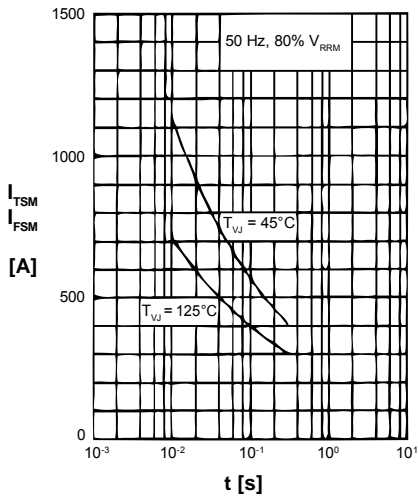

Fig. 1 Surge overload current
 I_{TSM} , I_{FSM} : Crest value, t: duration

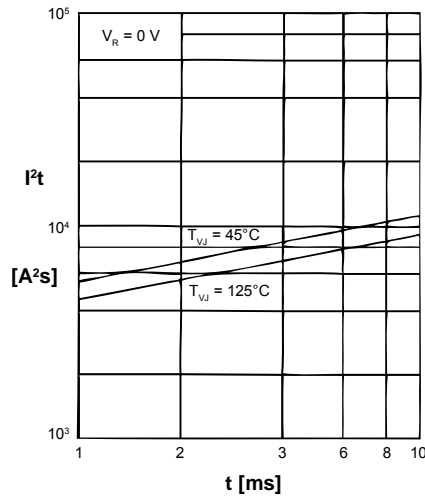

Fig. 2 I^2t versus time (1-10 ms)

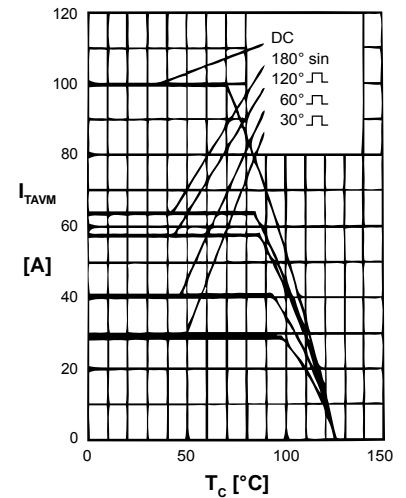

Fig. 3 Maximum forward current at case temperature

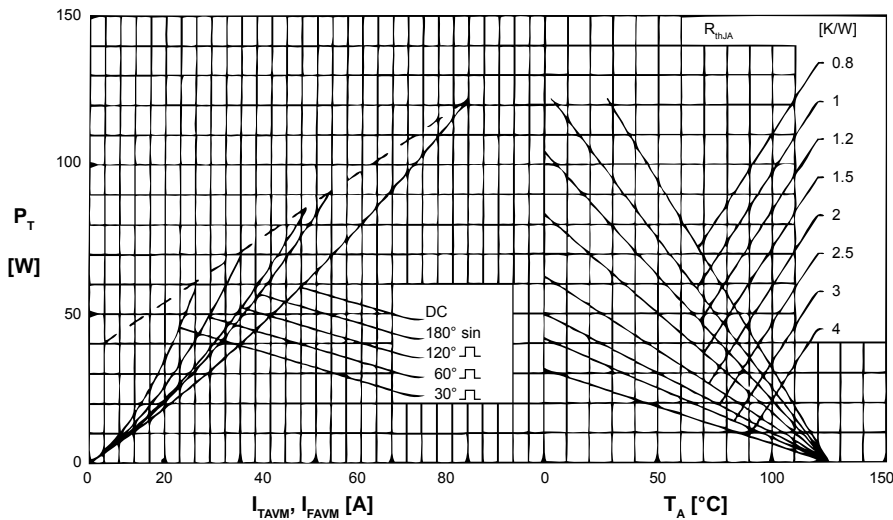

Fig. 4 Power dissipation vs. onstate current and ambient temperature (per thyristor/diode)

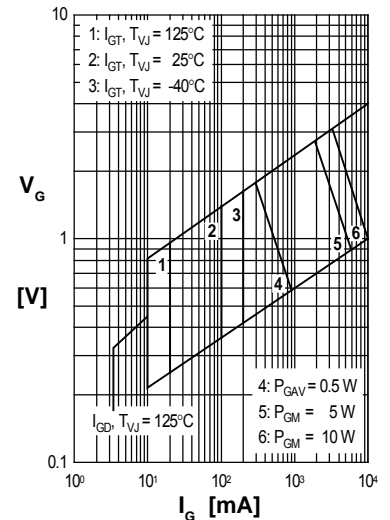

Fig. 5 Gate trigger charact.

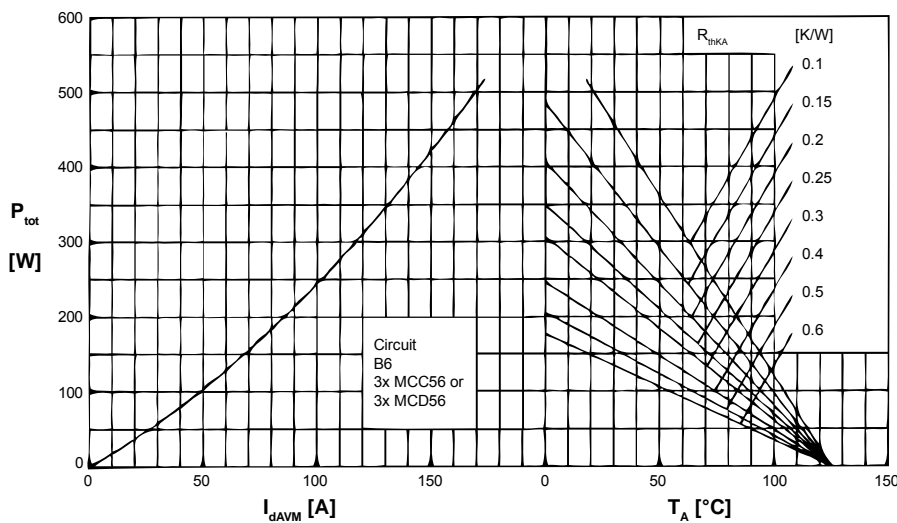

Fig. 6 Three phase rectifier bridge: Power dissipation versus direct output current and ambient temperature

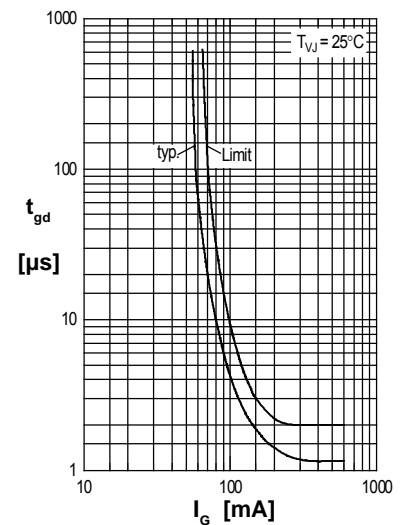

Fig. 7 Gate trigger delay time

Thyristor

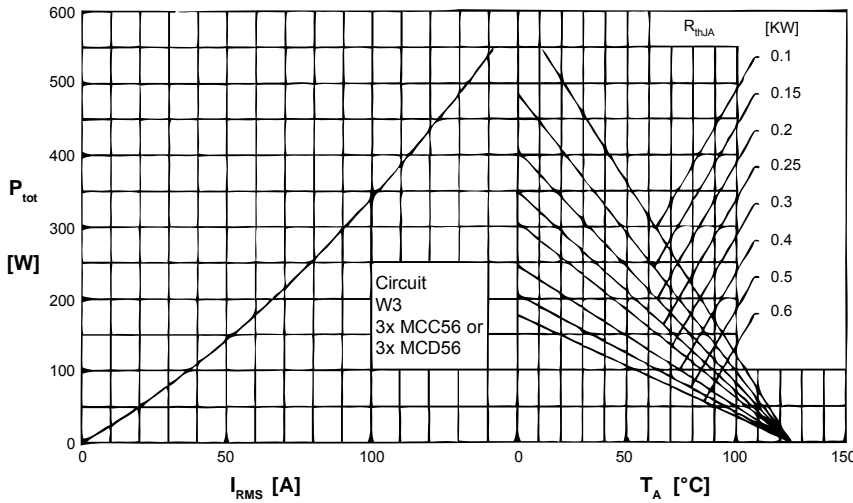

Fig. 8 Three phase AC-controller: Power dissipation vs. RMS output current and ambient temperature

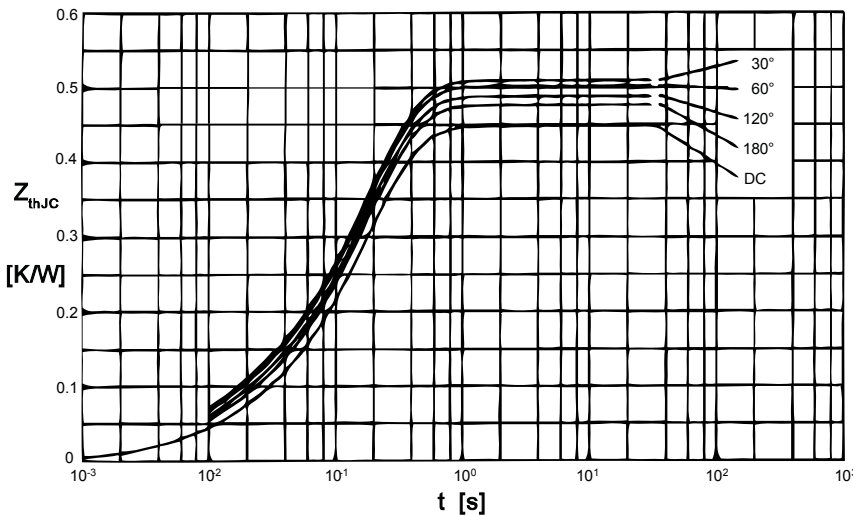

Fig. 9 Transient thermal impedance junction to case (per thyristor)

R_{thJC} for various conduction angles d:

| d | R_{thJC} [K/W] |
|------|------------------|
| DC | 0.450 |
| 180° | 0.470 |
| 120° | 0.490 |
| 60° | 0.505 |
| 30° | 0.520 |

Constants for Z_{thJC} calculation:

| i | R_{thi} [K/W] | t_i [s] |
|---|-----------------|-----------|
| 1 | 0.014 | 0.0150 |
| 2 | 0.026 | 0.0095 |
| 3 | 0.410 | 0.1750 |

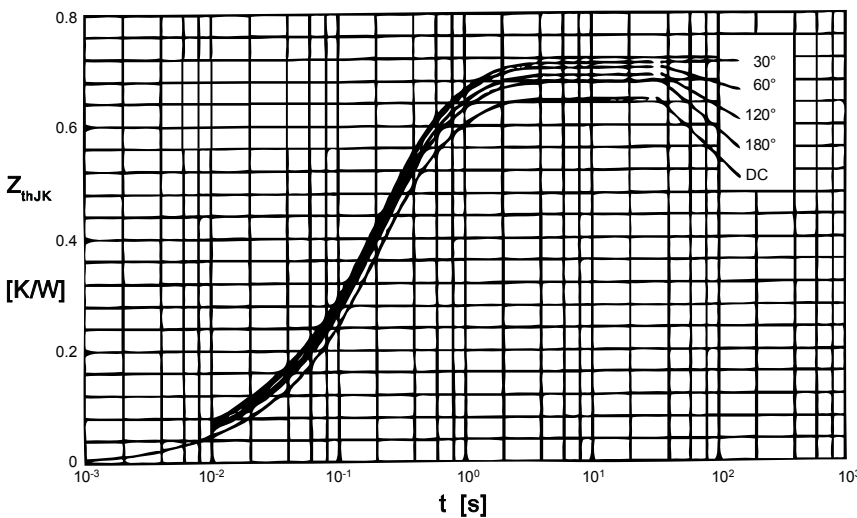

Fig. 10 Transient thermal impedance junction to heatsink (per thyristor)

R_{thJK} for various conduction angles d:

| d | R_{thJK} [K/W] |
|------|------------------|
| DC | 0.650 |
| 180° | 0.670 |
| 120° | 0.690 |
| 60° | 0.705 |
| 30° | 0.720 |

Constants for Z_{thJK} calculation:

| i | R_{thi} [K/W] | t_i [s] |
|---|-----------------|-----------|
| 1 | 0.014 | 0.0150 |
| 2 | 0.026 | 0.0095 |
| 3 | 0.410 | 0.1750 |
| 4 | 0.200 | 0.6700 |