

■ SPECIFICATION

PARAMETERS	VALUE	UNIT
Center Frequency	868.000	MHz
Gain	2	dBi
Impedance	50	Ω
VSWR, max	2	-
Return Loss, max	-10	dB
Polarization	Linear Vertical	-
Radiation	Omni-directional	-
Connector	R/A SMA Male	-
Length	47.5 ± 2	mm
Operating Temperature Range	-40 ~ +85	$^{\circ}\text{C}$
Power, max	1	W

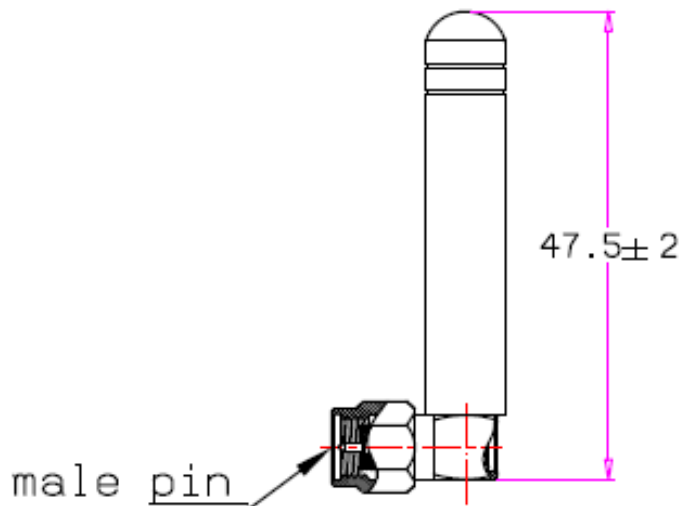

■ DIMENSIONS



FREQUENCY CHARACTERISTICS

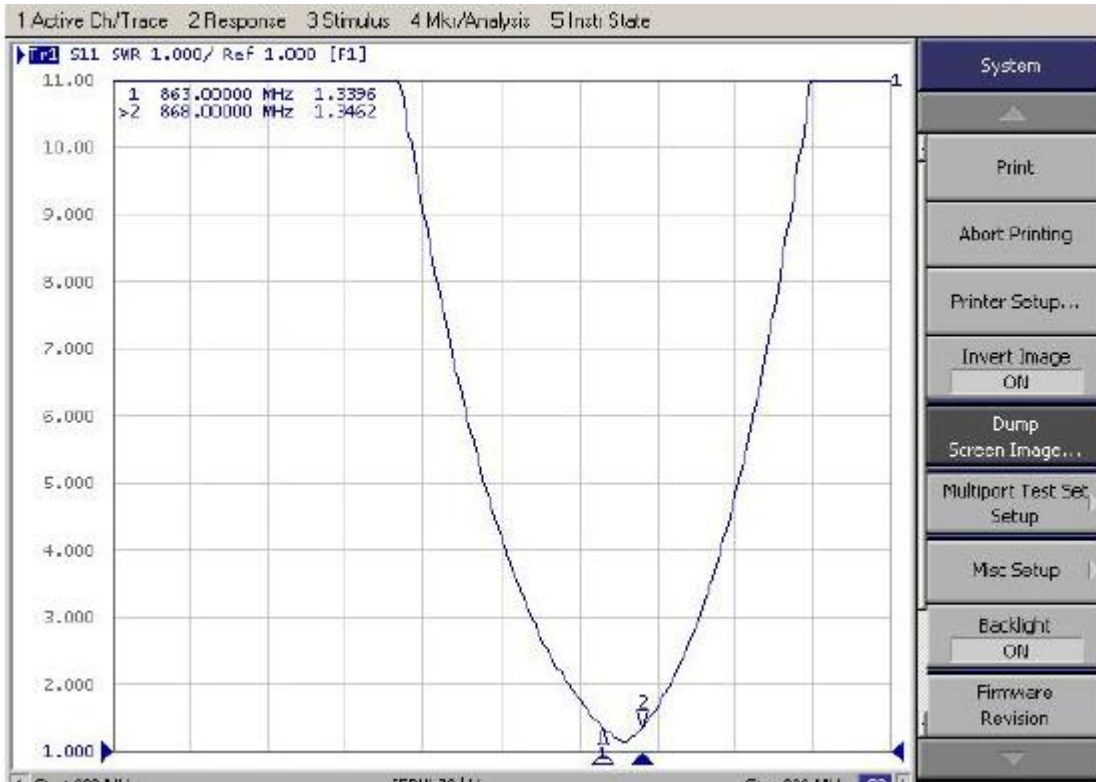

ANECHOIC CHAMBER TEST

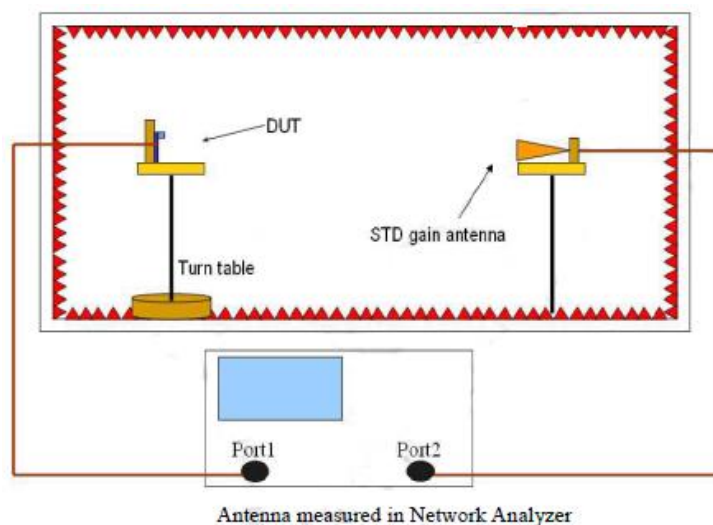

■ **GAIN AND EFFICIENCY**

Passive Test For 863-868MHz								
Freq (MHz)	Effi (%)	Effi (dB)	Gain (dBi)	Gain (dBd)	Max (dB)	Min (dB)	Attenut Hor	Attenut Ver
863	48.31	1.71	3.26	1.11	3.26	1.17	37.24	36.89
864	46.62	1.66	3.27	1.12	3.27	1.1	37.25	36.89
865	45.09	1.62	3.28	1.13	3.28	1	37.26	36.89
866	43.68	1.57	3.26	1.11	3.26	0.96	37.28	36.89
867	42.25	1.53	3.27	1.12	3.27	0.93	37.29	36.89
868	40.83	1.49	3.28	1.13	3.28	0.86	37.3	36.89

■ **RADIATION PATTERN**

863.000MHz

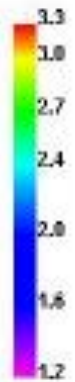
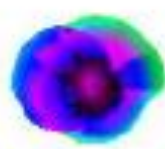

863.000MHz H

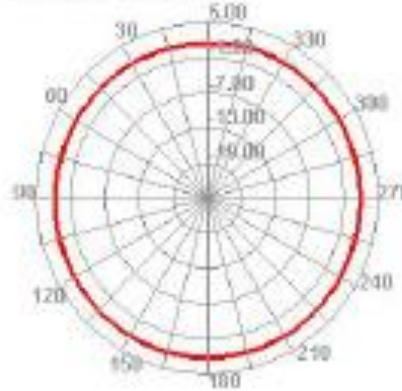

863.000MHz E1

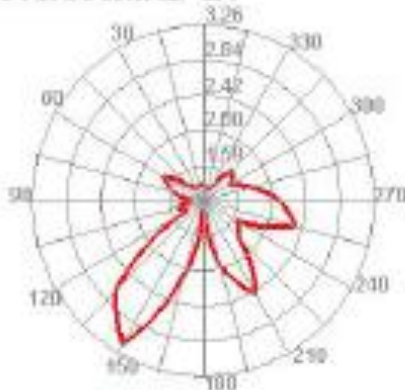

863.000MHz E2

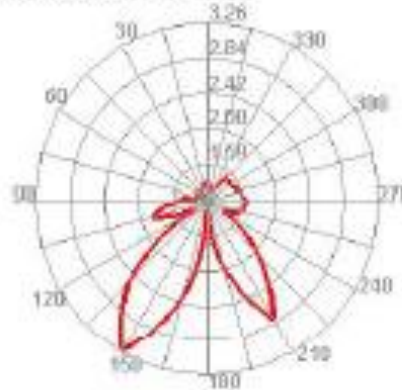

868.000MHz

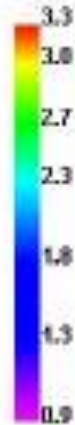
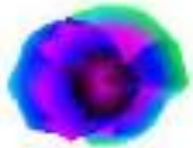

868.000MHz H

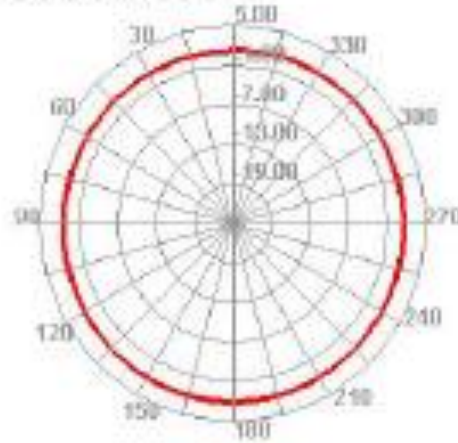

868.000MHz E1

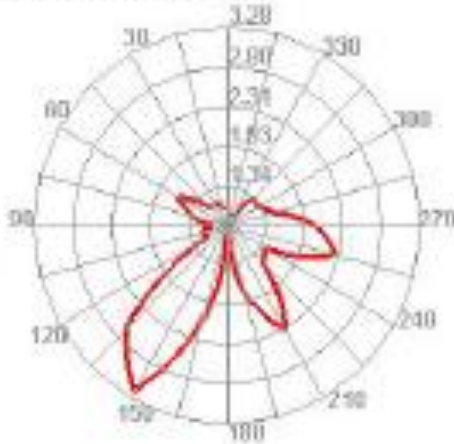

868.000MHz E2

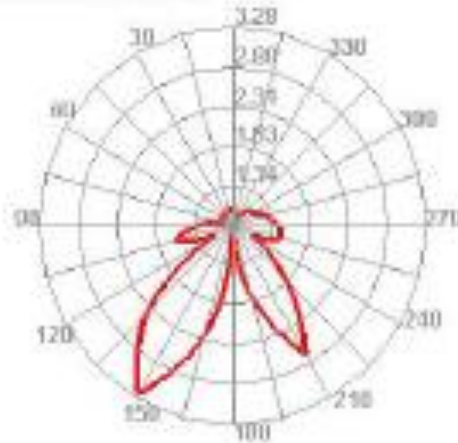

■ APPROVAL

RALTRON	
DRAWN BY:	AR, May 30, 2018
APPROVED BY:	CP, May 30, 2018
REVISION:	A, Initial Release

Raltron Electronics / RAMI Technology USA, LLC, including its affiliates, employees, agents and other persons acting on its behalf (collectively Raltron/RAMI Tech), disclaim any and all liability for any errors or inaccuracies contained in this data sheet. While Raltron/RAMI Tech has made every reasonable effort ensure the accuracy of all product information, specifications and data contained herein, Raltron/RAMI Tech does not guarantee that the information is accurate, reliable or current. The product information is provided only for reference purposes only and is subject to change, correction or revision, at any time without notice. Raltron/RAMI Tech does not assume any liability arising out of an application or use of any product described herein and disclaims any warranties expressed or implied. The user of products in such applications shall assume all risks of such use and will agree to hold Raltron/RAMI Tech, harmless against all damages.

Copyright © 2016, Raltron Electronics / RAMI Technology USA, LLC. All rights reserved. No part of this document may be reproduced in any form without the prior written permission of Raltron Electronics / RAMI Technology USA, LLC.