

Tilt Sensor Switch

| | | | | | |
|----------|-----------|-------------|---------------|---------------|----|
| Item No. | RBS311113 | Description | Photoelectric | Version | 12 |
| Page | 1 of 10 | | Publish Date | May. 25, 2018 | |

● FUNCTIONS

1. Tilt Angles: 15° within a 360° radius.
2. Suitable to vertical PCB.
3. Vibration Detecting

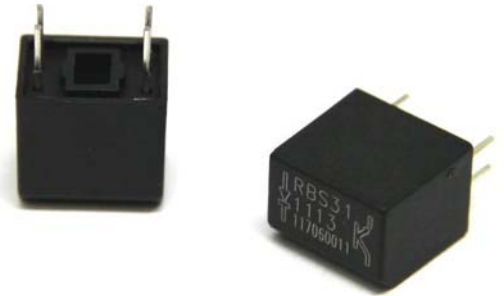

● APPLICATIONS

1. Rotation detection for LCD monitor
2. Automatically shut off for home appliances
3. Automatically shut off for Sporting equipment
4. Automatically shut off for motorbike
5. Alarm system
6. Anti-theft / Anti-tamper devices
7. Being motion detection (personal locator)
8. Wake up systems for power saving, such like remote controllers
9. Earthquake Detecting



Tilt Sensor Switch

| | | | | | |
|----------|-----------|-------------|---------------|---------------|----|
| Item No. | RBS311113 | Description | Photoelectric | Version | 12 |
| Page | 2 of 10 | | Publish Date | May. 25, 2018 | |

● **FEATURES**

1. Housing made of high insulation plastic material, free from electric conduction and rust problem.
2. Detecting with photo transistors, generating highly reliable and stable signals.
3. All plastic materials subject to industrial purpose, resist high temperature and meet fireproof function.
4. Simple ON and OFF signals, easy for design.
5. RoHS compliance, an ideal substitute for mercury switch.
6. A more economical tilt and vibration detection option than IC design solution.
7. All made in Taiwan and examined before shipment.

● **PATENTS**

1. Taiwan Patent No. I 310952
2. Taiwan Patent No. M 450817
3. U.S.A Patent No. US 6,800,841 B1
4. U.S.A Patent No. US 7,402,791 B2
5. China Patent No. ZL 200610083013.5
6. China Patent No. ZL 200820126206.9
7. China Patent No. ZL 201220539712.7
8. Japan Patent No. 4384217
9. Japan Patent No. 3148127



Tilt Sensor Switch

| | | | | | |
|----------|-----------|-------------|---------------|---------------|----|
| Item No. | RBS311113 | Description | Photoelectric | Version | 12 |
| Page | 3 of 10 | | Publish Date | May. 25, 2018 | |

● DIMENSIONS / OPERATION / P.C.B. LAYOUT (Unit: mm, Tolerance: ±0.25mm)

Fig. 1

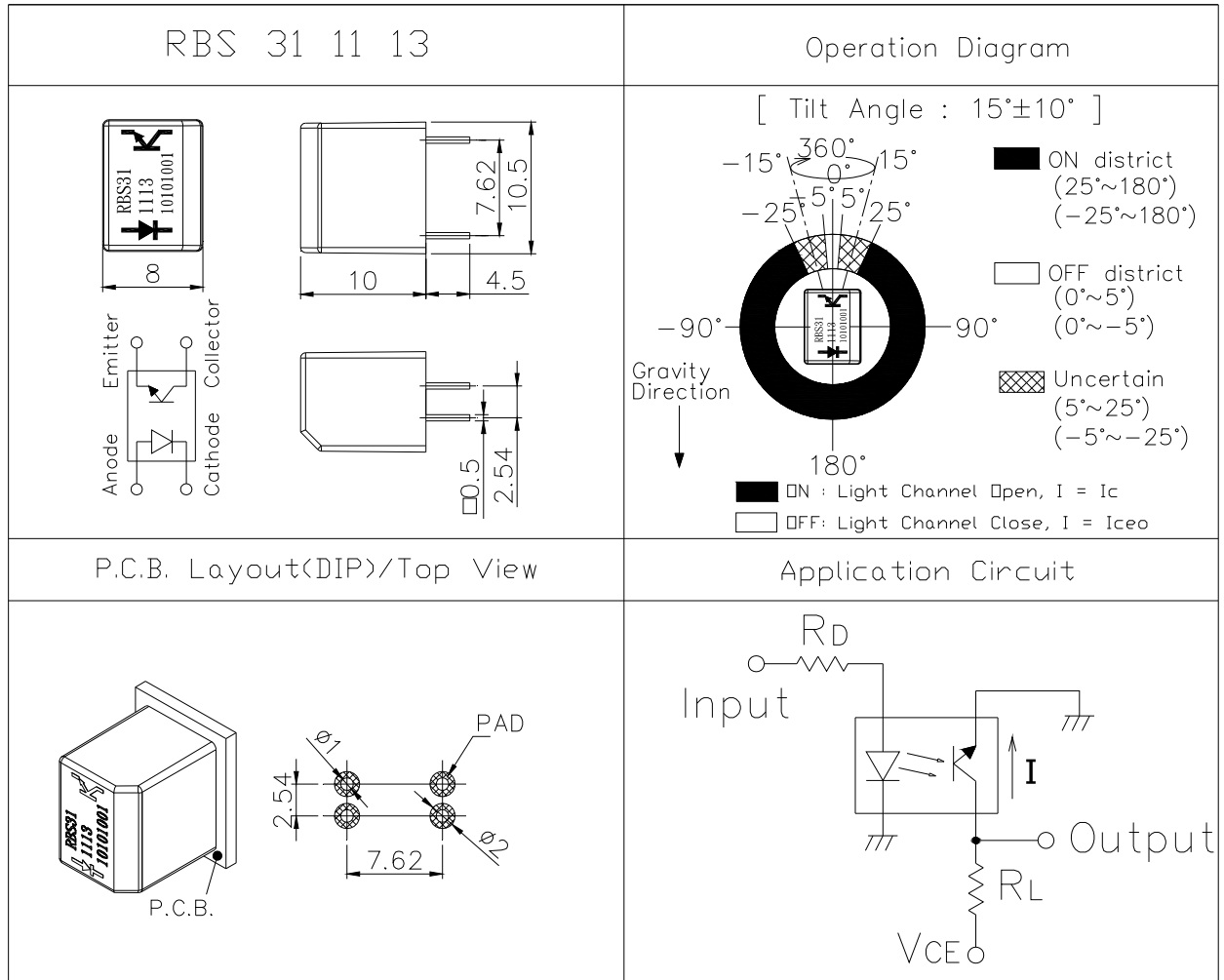

Tilt Sensor Switch

| | | | | | |
|----------|-----------|-------------|---------------|---------------|----|
| Item No. | RBS311113 | Description | Photoelectric | Version | 12 |
| Page | 4 of 10 | | Publish Date | May. 25, 2018 | |

● Current/Voltage Suggested

| Input Current (mA) | Operating Voltage (V) | Conditions |
|--------------------|-----------------------|---|
| 10 | 3.3 | $V_{CE}=3.3V$ $R_D=200\text{ ohm}$ $R_L=33K\text{ ohm}$ |
| 10 | 5 | $V_{CE}=5V$ $R_D=390\text{ ohm}$ $R_L=33K\text{ ohm}$ |

* Please refer to above Application Circuit for designing electrical circuit.

● Absolute Maximum Rating ($T_a=25^{\circ}C$)

| Item | | Symbol | Rating | Unit |
|----------------------------|-----------------------------|-----------|---------|-------------|
| Input | Power Dissipation | P_d | 75 | mW |
| | Reverse Voltage | V_R | 5 | V |
| | Forward Current | I_F | 50 | mA |
| | Peak Forward Current (*1) | I_{FP} | 1 | A |
| Output | Collector Power Dissipation | P_C | 100 | mW |
| | Collector Current | I_C | 20 | mA |
| | C-E Voltage | V_{CEO} | 30 | V |
| | E-C Voltage | V_{ECO} | 5 | V |
| Operating Temperature | | T_{opr} | -25~+85 | $^{\circ}C$ |
| Storage Temperature | | T_{stg} | -40~+85 | $^{\circ}C$ |
| Soldering Temperature (*2) | | T_{sol} | 260 | $^{\circ}C$ |

(*1) $t_w=100\ \mu\text{Sec.}$ 、 $T=10\ \text{mSec.}$

(*2) $t=5\ \text{Sec}$



Tilt Sensor Switch

| | | | | | |
|----------|-----------|-------------|---------------|---------------|----|
| Item No. | RBS311113 | Description | Photoelectric | Version | 12 |
| Page | 5 of 10 | | Publish Date | May. 25, 2018 | |

● Electrical Optical Characteristics (Ta=25°C)

| Parameter | Symbol | Condition | Min. | Typ. | Max. | Unit |
|------------------------|---------------|-----------------------------|------|------|------|-----------|
| Forward Voltage | V_F | $I_F=20mA$ | - | 1.2 | 1.5 | V |
| Reverse Current | I_R | $V_R=5V$ | - | - | 10 | μA |
| Peak Wavelength | λ_p | $I_F=10mA$ | | 940 | | nm |
| Dark Current | I_{ceo} | $V_{CE}=10V$ | - | - | 2 | μA |
| C-E Saturation Voltage | $V_{CE(sat)}$ | $I_C=0.25mA$ $I_F=20mA$ | - | - | 0.4 | V |
| Light Current | I_C | $V_{CE}=5V$ $I_F=20mA$ | 0.5 | 5 | - | mA |
| Rise Time | T_r | $I_C=0.8mA$ $V_{CC}=30V$ | - | 5 | - | μsec |
| Fall Time | T_f | $R_L=1K\Omega$ | - | 5 | - | μsec |
| Operation Diagram | θ | Fig. 1 | 5 | 15 | 25 | ° |



Tilt Sensor Switch

| | | | | | |
|----------|-----------|-------------|---------------|---------------|----|
| Item No. | RBS311113 | Description | Photoelectric | Version | 12 |
| Page | 6 of 10 | | Publish Date | May. 25, 2018 | |

● Typical Electrical / Optical Characteristics Curves (Ta=25°C)

Fig.1 Power Dissipation vs. Ambient Temperature

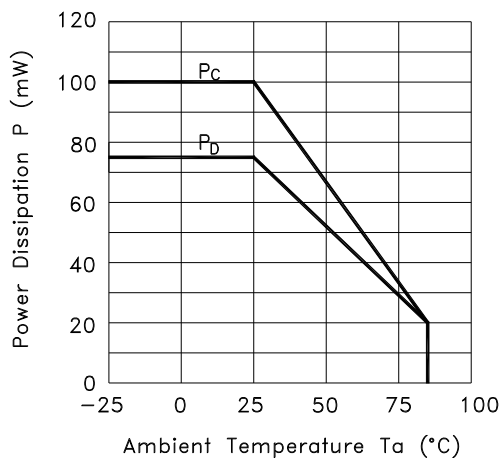

Fig.2 Forward Current vs. Forward Voltage

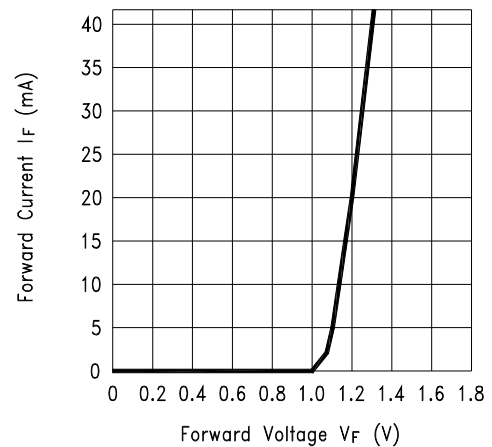

Fig.3 Collector Current vs. Collector-emitter Voltage

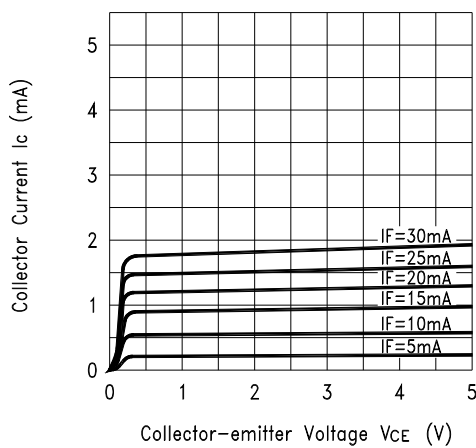
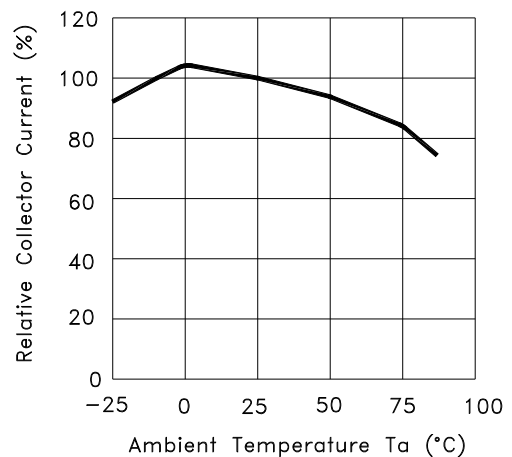

Fig.4 Collector Current vs. Ambient Temperature



Tilt Sensor Switch

| | | | | | |
|----------|-----------|-------------|---------------|---------------|----|
| Item No. | RBS311113 | Description | Photoelectric | Version | 12 |
| Page | 7 of 10 | | Publish Date | May. 25, 2018 | |

Fig.5 Collector-emitter Saturation Voltage vs. Ambient Temperature

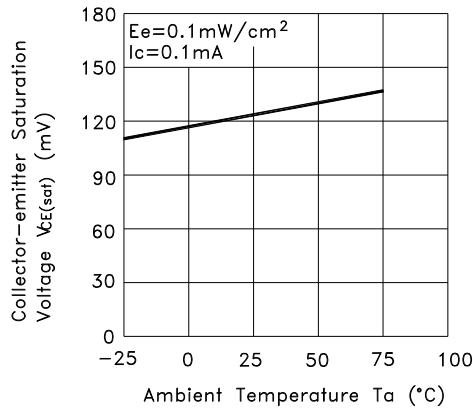

Fig.6 Response Time vs. Load Resistance

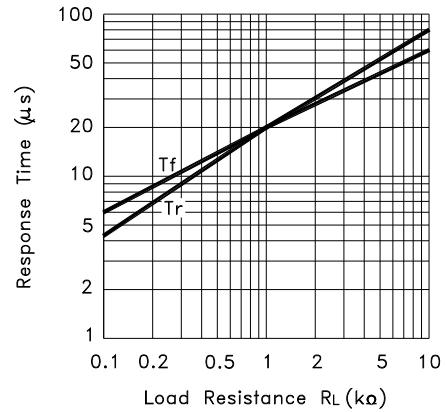
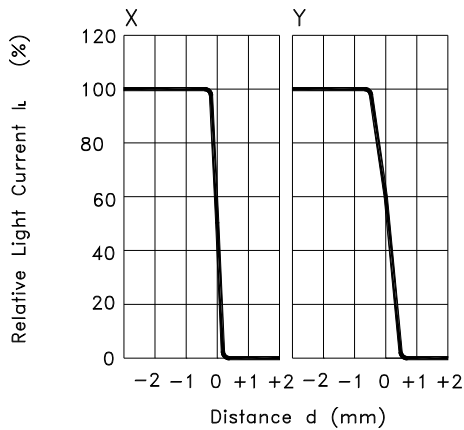
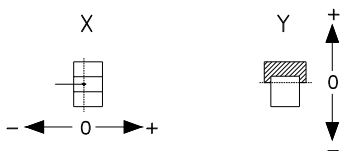

Fig.7 Sensing Position Characteristics (Typical)



(Center of Optical axis)



Test Circuit for Response Time

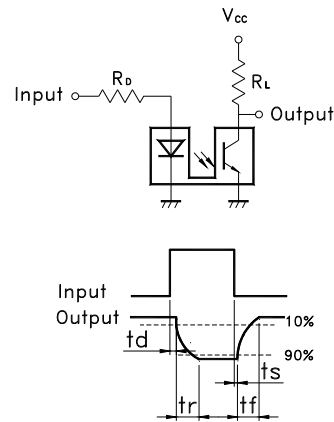

Tilt Sensor Switch

| | | | | | |
|----------|-----------|-------------|---------------|---------------|----|
| Item No. | RBS311113 | Description | Photoelectric | Version | 12 |
| Page | 8 of 10 | | Publish Date | May. 25, 2018 | |

● RELIABLE TEST ITEMS

Reliable Test for RBS311113

| | Test Item | Test Content |
|---|-----------------------|---|
| 1 | Operation Temperature | -25°C ~ 85°C |
| 2 | Storage Temperature | -40°C ~ 85°C |
| 3 | Humidity | 40 °C / 95 %RH |
| 4 | Mechanical Life | 2Hz, horizontal 1,000,000 times |
| 5 | Electrical Life | I _F =20 mA, V _{CE} =5 V TIME: 30,000 hrs |

● SOLDERING CONDITION

Following soldering conditions are for reference only, please use soldering information that solder paste manufacturer recommends.

| Condition | Soldering Temperature | Soldering Time | Wattage of Manual Soldering | Type |
|------------------|-----------------------|------------------|--|------|
| Wave Soldering | 260±5°C | < 5 seconds max. | - | DIP |
| Manual Soldering | 300±5°C | < 3 seconds max. | 30W or Temperature-controlled manual soldering | DIP |



Tilt Sensor Switch

| | | | | | |
|----------|-----------|-------------|---------------|---------------|----|
| Item No. | RBS311113 | Description | Photoelectric | Version | 12 |
| Page | 9 of 10 | | Publish Date | May. 25, 2018 | |

● PACKAGE

| | Part Number | Package | Quantity | Total | Dimension(mm) |
|----|-------------|--------------|----------|------------|----------------|
| 1. | RBS311113 | IC tube | 48 pcs | 48 pcs | 525L*10W*17.5H |
| | | Inner box | 84 tubes | 4,032 pcs | 539L*130W*130H |
| | | Outer carton | 4 boxes | 16,128 pcs | 551L*285W*288H |

※ Package shown as below for reference.

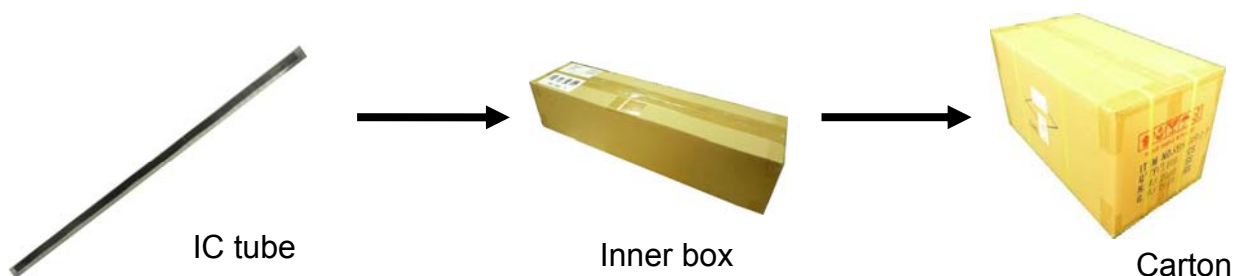

Tilt Sensor Switch

| | | | | | |
|----------|-----------|-------------|---------------|---------------|----|
| Item No. | RBS311113 | Description | Photoelectric | Version | 12 |
| Page | 10 of 10 | | Publish Date | May. 25, 2018 | |

● NOTES

1. Suggestion for usage: For vibration usage or application, we suggest to add hysteresis for IC.
2. For the continued product improvement as one of the company policy, specifications may change or update without notice. The latest information can be obtained through our sales offices. Normally, all products are supplied under our standard conditions.

● PRECAUTIONS FOR USE

1. If the products are intended to be used for other endurance equipment requiring higher safety and reliability such as life support system, space and aviation devices, disaster and safety system, it's necessary to make verification of conformity or contact us for the details before using.
2. Do not try to clean the switch with a solvent or similar substance after the soldering process.
3. Use water-soluble flux may damage the switch.
4. Please follow the soldering instruction accordingly, otherwise might lead to defective.
5. Do not use switch in the environment of high humidity, because such an environment may cause the leakage current between the terminals.
6. Please do not exceed the rated load as there will be a risk of disabling the product function.
7. In the circuit, switch should not be near or directly connected with the magnetic component solder joints (for example: relays, transformers, etc.).
8. To prevent damaging IR and PT, please make electrostatic protective treatment, for example: wearing a conductive wrist strap or antistatic gloves during production process, and grounding machinery etc.

