

REVISION RECORD				
REV	ECN	DESCRIPTION	DRFT	DATE

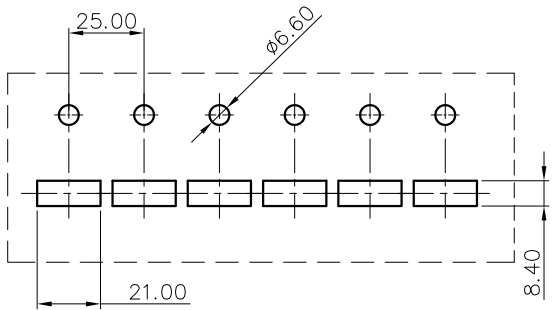

LAYOUT

DGH95J-01P-1Y-00A(H)

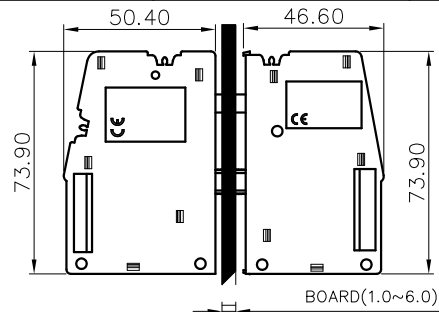
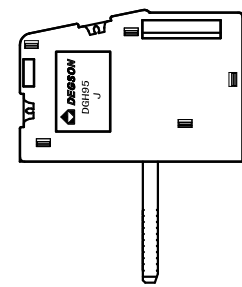
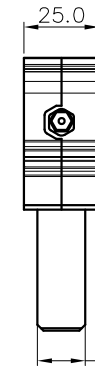
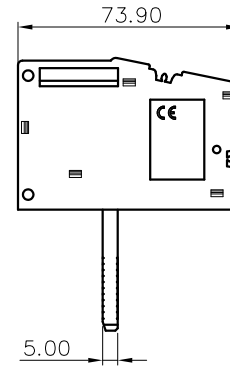
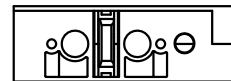
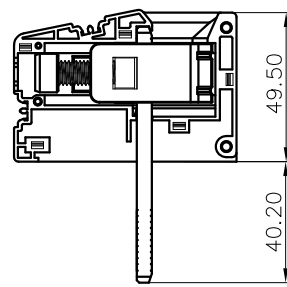

NOTES1:

UL Standard

- 1.Rated voltage/current : 600V / 230A
- 2.Withstanding voltage : AC2200V/1Min.
- 3.Torque value : M8 , 132.81Lb.in
- 4.Wire range : 4~4/0AWG

IEC Standard

1. Pollution degree	3
Overvoltage category	III
Rate impulse voltage(KV)	8.0KV
Rate voltage(V)	1000V
Rate current(A)	232 A

- 2.Torque value : M8 , 15N·m
- 3.Wire range : 25~95mm<sup>2</sup>

NOTES2:

- 1.Dimension shall be interpreted per ASME Y14.5-2009
- 2.Pitch : 25.0mm, Poles : N=01P
- 3.Stripping length : 27mm
- 4.Operating temperature : -40°C~+105°C
- 5.Undimensioned tolerances:

Pitch range in mm		Nominal dimension range in mm							0.1/10
Over 6 TO 10	Over 10 TO 24	Over 30 TO 30	Over 60 TO 60	Over 100 TO 100	Over 150 TO 150	Over 150 TO 150	Over 150 TO 150	0.1/10	
±0.15	±0.20	±0.30	±0.50	±0.70	±1.00	±1.30	±2*	<	

- 6.RoHS Compliance

DGH95K-01P-1Y-00A(H)

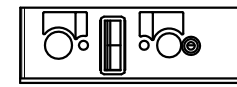
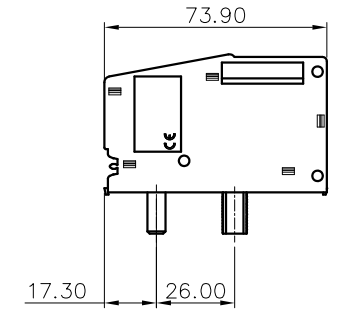
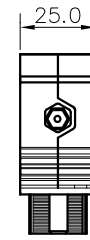
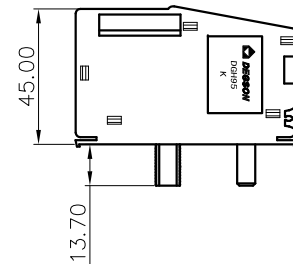

DGH95 - 01P - 1Y - 00A (H)  
 (Series No.) (Poles) (Single Pitch) (Color):1.(Grey)  
 2.(Blue)  
 3.(Black)  
 4.(Green)  
 5.(Orange)  
 6.(Red)  
 7.(Transparent)  
 8.(Yellow)  
 9.(White)  
 (RoHS)  
 00A-(Standard)

DETACHED LISTS	PART NO.:	NINGBO DEGSON ELECTRICAL CO., LTD			
	APPD:	NAME: DGH95-01P-1Y-00A(H)			
	CHKD:	TITLE: CUSTOMER DRAWING			
	DRFT:	DRAWING NO.:		REV	D0
	THIRD ANGLE PROJECTION		MM (INCH)	SHEET	1/1

DO NOT SCALE DRAWING SCALE 1:1