

## Cree® XLamp® CXB1830 LED



### PRODUCT DESCRIPTION

The XLamp® CXB1830 LED Array is a member of the second generation of the CXA family that delivers up to 30% higher efficacy and up to 20% higher lumens than the first generation in the same LES. The higher performance second generation CXA LED Arrays provide a drop-in performance upgrade to existing CXA LED designs to shorten product development time. In addition, the CXB LEDs also allow lighting manufacturers to achieve the same or better performance with a smaller LES, enabling a smaller, more impactful luminaire. Available in 2-step, 3-step and 5-step EasyWhite® bins, the CXB1830 LED delivers high lumen output and high efficacy in a single, easy-to-use package that eliminates the need for reflow soldering.

The [CX Family LED Design Guide](#) provides basic information on the requirements to use the CXB1830 LED successfully in luminaire designs.

### FEATURES

- 14-mm optical source
- Optical design consistent with CXA1830 LEDs
- Available in 70-, 80- and 90-minimum CRI options
- Cree EasyWhite® 2-, 3- and 5-step binning
- Forward voltage option: 36-V class
- 85 °C binning and characterization
- Extremely uniform color over viewing angle
- Top-side solder connections
- Thermocouple attach point
- NEMA SSL-3 2011 standard flux bins
- RoHS- and REACH-compliant
- UL® recognized component (E349212)

### TABLE OF CONTENTS

Characteristics .....	2
Operating Limits.....	2
Flux Characteristics, EasyWhite® Order Codes and Bins .....	3
Relative Spectral Power Distribution .....	5
Electrical Characteristics.....	6
Relative Luminous Flux.....	7
Typical Spatial Distribution.....	8
Performance Groups - Brightness .....	8
Performance Groups - Chromaticity.....	9
Cree EasyWhite® Bins Plotted on the 1931 CIE Color Space .....	10
Bin and Order Code Formats.....	12
Mechanical Dimensions .....	12
Thermal Design.....	13
Notes .....	14
Packaging.....	15



**CHARACTERISTICS**

Characteristics	Unit	Minimum	Typical	Maximum
Viewing angle (FWHM)	degrees		115	
ESD withstand voltage (HBM per Mil-Std-883D)	V			8000
DC forward current	mA			1400*
Reverse current	mA			0.1
Forward voltage (@ 800 mA, 85 °C)	V		35	38

\* Refer to the Operating Limits section.

**OPERATING LIMITS**

The maximum current rating of the CXB1830 is dependent on the case temperature (Tc) when the LED has reached thermal equilibrium under steady-state operation. The graph shown below assumes that the system design employs good thermal management (thermal interface material and heat sink) and may vary when poor thermal management is employed. Please refer to the Mechanical Dimensions section on page 12 for the location of the Tc measurement point.

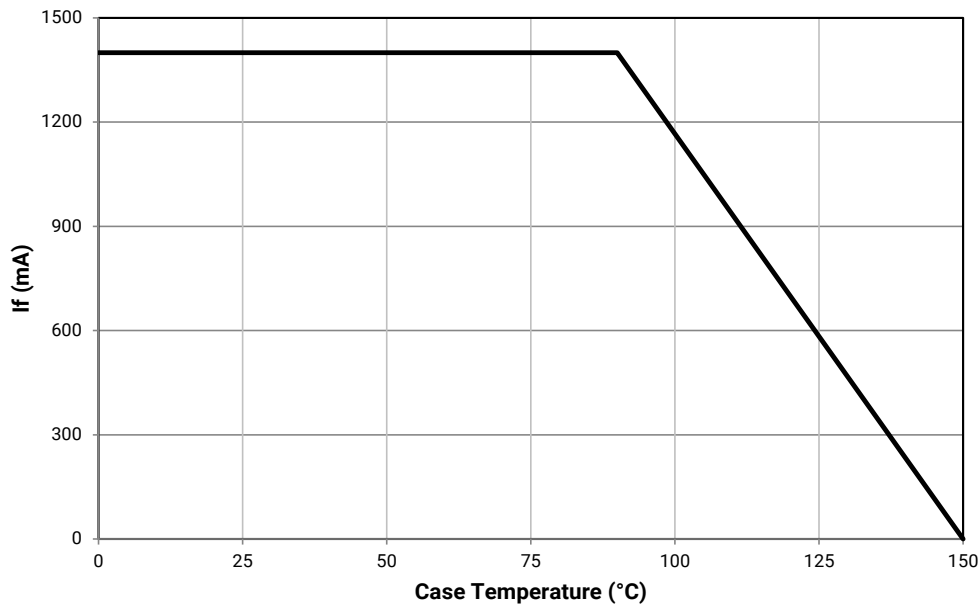

**FLUX CHARACTERISTICS, EASYWHITE® ORDER CODES AND BINS ( $I_F = 800 \text{ mA}$ ,  $T_J = 85 \text{ °C}$ )**

The following table provides order codes for XLamp CXB1830 LEDs. For a complete description of the order code nomenclature, please see the Bin and Order Code Formats section (page 12).

Nominal CCT	CRI*		Minimum Luminous Flux			2-Step		3-Step				5-Step	
	Min	Typ	Group	Flux (lm) @ 85 °C	Flux (lm) @ 25 °C**	Group	Order Code	Group	Order Code	Group	Order Code	Group	Order Code
6500 K	70	---	U4	3955	4332							65E	CXB1830-0000-000N0BU465E
			V2	4230	4633								CXB1830-0000-000N0BV265E
	80	---	U4	3955	4332							65E	CXB1830-0000-000N0HU465E
			V2	4230	4633								CXB1830-0000-000N0HV265E
5700 K	70	---	U4	3955	4332							57E	CXB1830-0000-000N0BU457E
			V2	4230	4633								CXB1830-0000-000N0BV257E
	80	---	U4	3955	4332							57E	CXB1830-0000-000N0HU457E
			V2	4230	4633								CXB1830-0000-000N0HV257E
5000 K	70	---	U4	3955	4332							50E	CXB1830-0000-000N0BU450E
			V2	4230	4633								CXB1830-0000-000N0BV250E
	80	---	U4	3955	4332			50G	CXB1830-0000-000N0HU450G			50E	CXB1830-0000-000N0HU450E
			V2	4230	4633								CXB1830-0000-000N0HV250E
	90	92	T4	3440	3768			50G	CXB1830-0000-000N0UT450G				
			U2	3680	4031								
4000 K	70	---	U4	3955	4332							40E	CXB1830-0000-000N0BU440E
			V2	4230	4633								CXB1830-0000-000N0BV240E
	80	---	U2	3680	4031	40H	CXB1830-0000-000N0HU240H	40G	CXB1830-0000-000N0HU240G				
			U4	3955	4332								
	90	92	T2	3200	3505	40H	CXB1830-0000-000N0UT240H	40G	CXB1830-0000-000N0UT240G				
			T4	3440	3768								

**Notes**

- Cree maintains a tolerance of  $\pm 7\%$  on flux and power measurements,  $\pm 0.005$  on chromaticity (CCx, CCy) measurements and a tolerance of  $\pm 2$  on CRI measurements. See the Measurements section (page 14).
- Cree XLamp CXB1830 LED order codes specify only a minimum flux bin and not a maximum. Cree may ship reels in flux bins higher than the minimum specified by the order code without advance notice. Shipments will always adhere to the chromaticity bin restrictions specified by the order code.
- \* For 80 CRI minimum LEDs, CRI R9 minimum is 0 with a  $\pm 2$  tolerance. For 90 CRI minimum LEDs, CRI R9 typical is 60.
- \*\* Flux values @ 25 °C are calculated and for reference only.

**FLUX CHARACTERISTICS, EASYWHITE® ORDER CODES AND BINS ( $I_F = 800 \text{ mA}$ ,  $T_J = 85 \text{ °C}$ ) - CONTINUED**

Nominal CCT	CRI*		Minimum Luminous Flux			2-Step		3-Step				5-Step	
	Min	Typ	Group	Flux (lm) @ 85 °C	Flux (lm) @ 25 °C**	Group	Order Code	Group	Order Code	Group	Order Code	Group	Order Code
3500 K	80	---	U2	3680	4031	35H	CXB1830-0000-000N0HU235H	35G	CXB1830-0000-000N0HU235G				
			U4	3955	4332		CXB1830-0000-000N0HU435H		CXB1830-0000-000N0HU435G				
	90	92	S4	2990	3275	35H	CXB1830-0000-000N0US435H	35G	CXB1830-0000-000N0US435G				
			T2	3200	3505		CXB1830-0000-000N0UT235H		CXB1830-0000-000N0UT235G				
			T4	3440	3768		CXB1830-0000-000N0UT435H		CXB1830-0000-000N0UT435G				
	3000 K	80	---	U2	3680	4031	30H	CXB1830-0000-000N0HU230H	30G	CXB1830-0000-000N0HU230G			
U4				3955	4332	CXB1830-0000-000N0HU430H		CXB1830-0000-000N0HU430G					
90		92	S4	2990	3275	30H	CXB1830-0000-000N0US430H	30G	CXB1830-0000-000N0US430G				
			T2	3200	3505		CXB1830-0000-000N0UT230H		CXB1830-0000-000N0UT230G				
90		92	S2	2780	3030			30Q		30U	CXB1830-0000-000N0US230U		
			S4	2990	3275				CXB1830-0000-000N0US430Q		CXB1830-0000-000N0US430U		
		T2	3200	3505			CXB1830-0000-000N0UT230Q		CXB1830-0000-000N0UT230U				
2700 K	80	---	T4	3440	3768	27H	CXB1830-0000-000N0HT427H	27G	CXB1830-0000-000N0HT427G				
			U2	3680	4031		CXB1830-0000-000N0HU227H		CXB1830-0000-000N0HU227G				
	90	92	S2	2780	3045	27H	CXB1830-0000-000N0US227H	27G	CXB1830-0000-000N0US227G				
			S4	2990	3275		CXB1830-0000-000N0US427H		CXB1830-0000-000N0US427G				

**Notes**

- Cree maintains a tolerance of  $\pm 7\%$  on flux and power measurements,  $\pm 0.005$  on chromaticity (CCx, CCy) measurements and a tolerance of  $\pm 2$  on CRI measurements. See the Measurements section (page 14).
- Cree XLamp CXB1830 LED order codes specify only a minimum flux bin and not a maximum. Cree may ship reels in flux bins higher than the minimum specified by the order code without advance notice. Shipments will always adhere to the chromaticity bin restrictions specified by the order code.
- \* For 80 CRI minimum LEDs, CRI R9 minimum is 0 with a  $\pm 2$  tolerance. For 90 CRI minimum LEDs, CRI R9 typical is 60.
- \*\* Flux values @ 25 °C are calculated and for reference only.

**RELATIVE SPECTRAL POWER DISTRIBUTION**

The following graph is the result of a series of pulsed measurements at 800 mA and  $T_j = 85^\circ\text{C}$ .

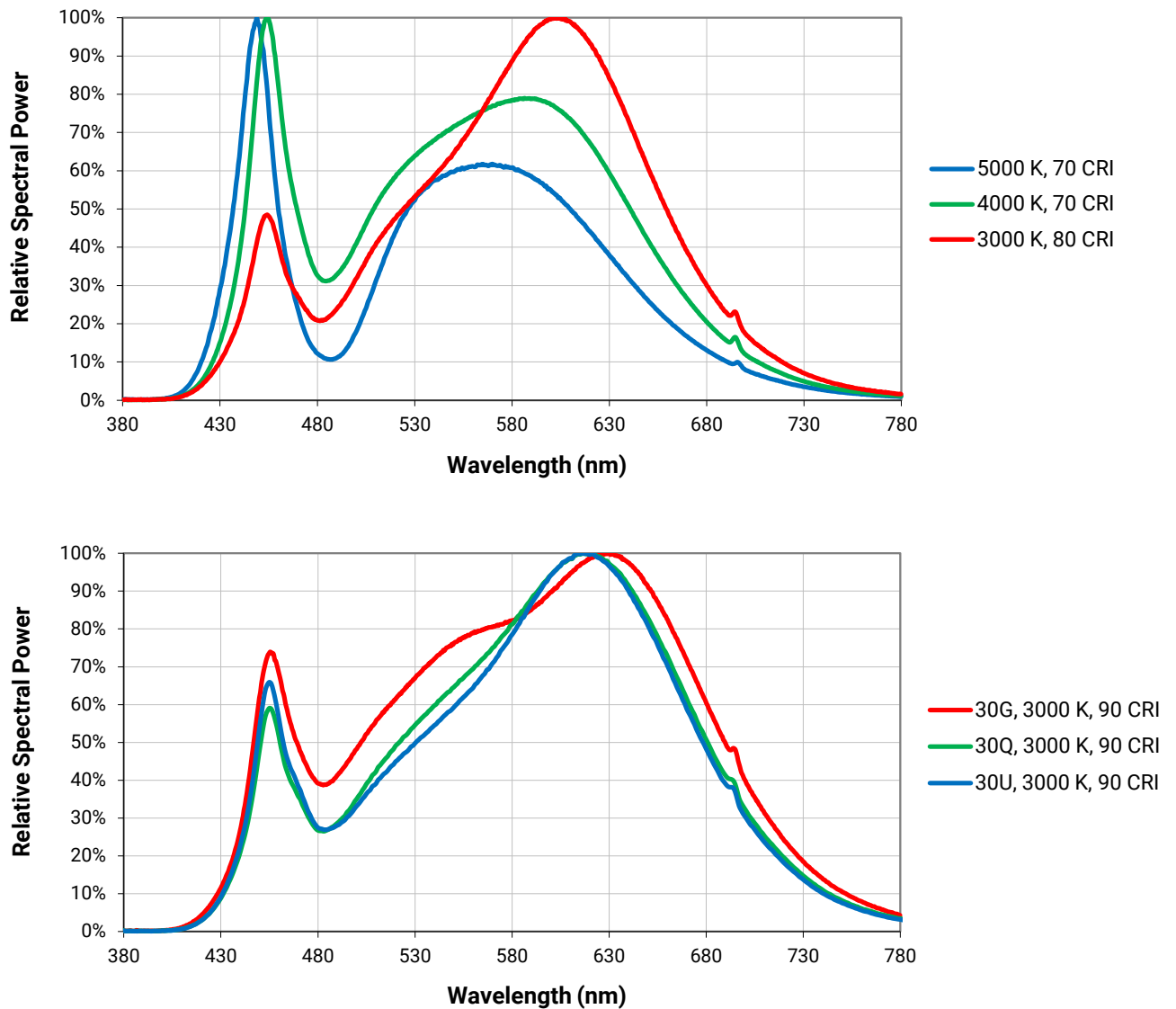

**ELECTRICAL CHARACTERISTICS**

The following graph is the result of a series of steady-state measurements.

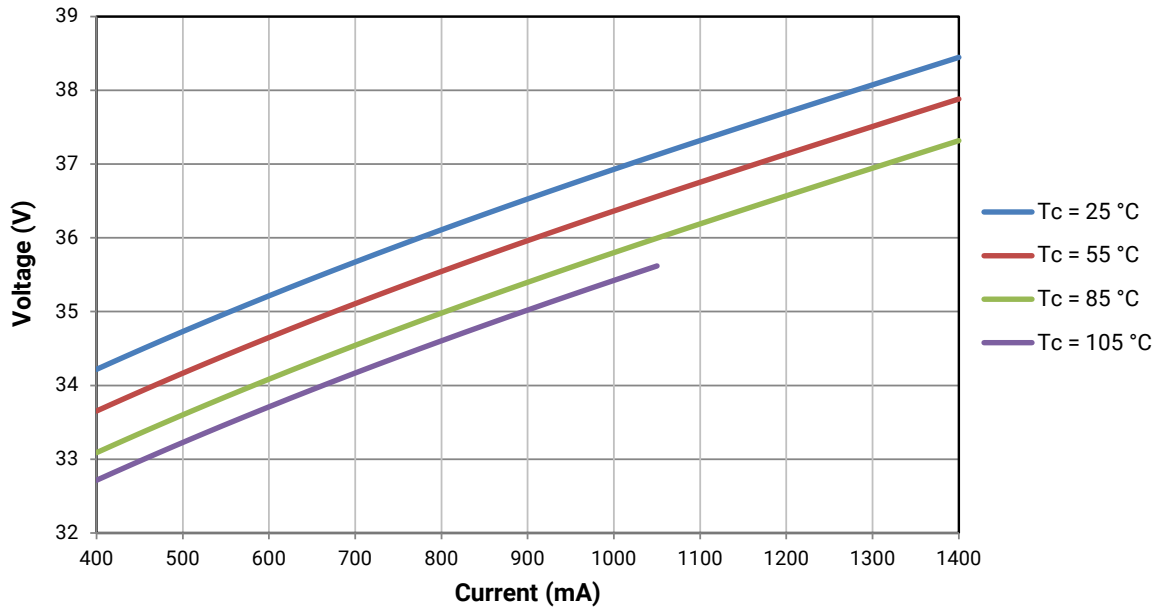

**RELATIVE LUMINOUS FLUX**

The relative luminous flux values provided below are the ratio of measurements of the CXB1830 LED at steady-state operation at the given conditions, divided by the flux measured during binning, which is a pulsed measurement at 800 mA at  $T_j = 85^\circ\text{C}$ .

For example, at steady-state operation of  $T_c = 25^\circ\text{C}$ ,  $I_f = 900\text{ mA}$ , the relative luminous flux ratio is 120% in the chart below. A CXB1830 LED that measures 3200 lm during binning will deliver 3840 lm ( $3200 \times 1.2$ ) at steady-state operation of  $T_c = 25^\circ\text{C}$ ,  $I_f = 900\text{ mA}$ .

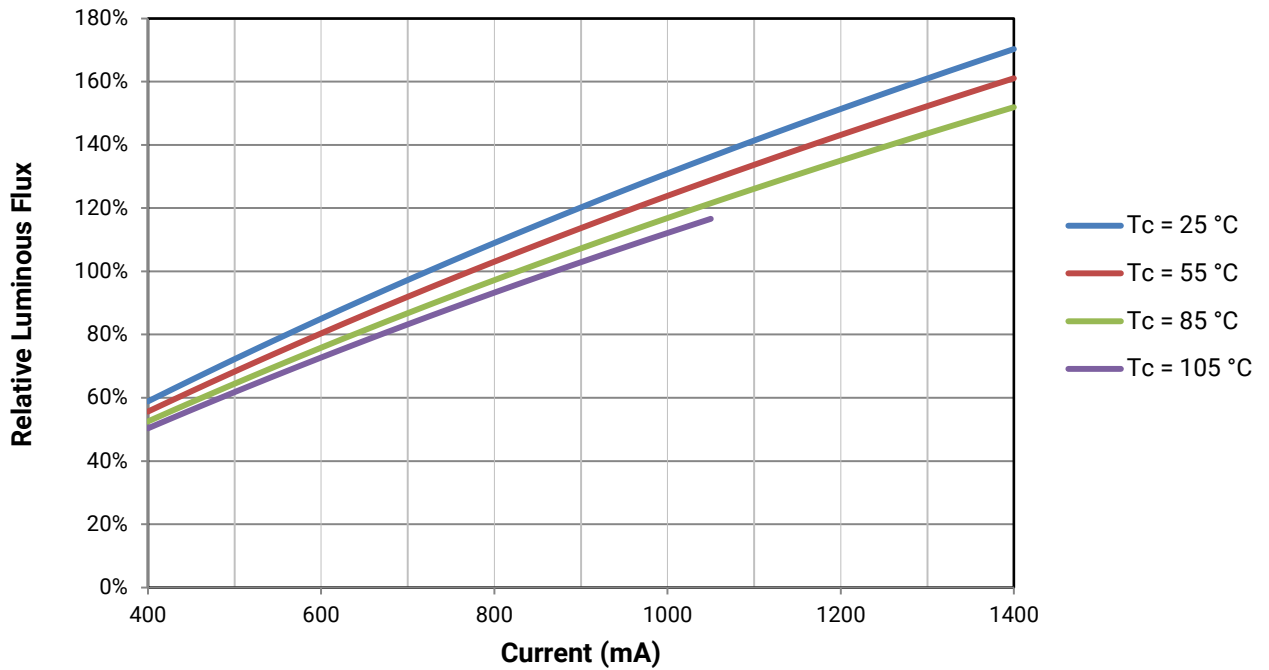

**TYPICAL SPATIAL DISTRIBUTION**

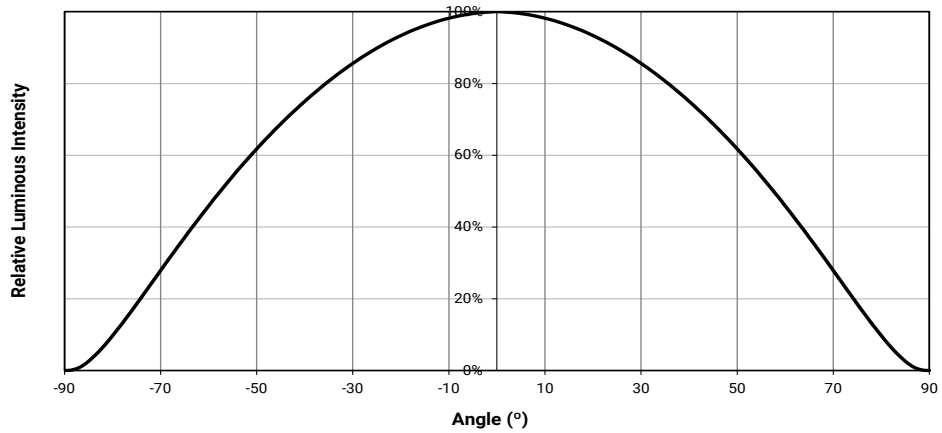

**PERFORMANCE GROUPS - BRIGHTNESS ( $I_F = 800\text{ mA}$ ,  $T_J = 85\text{ °C}$ )**

XLamp CXB1830 LEDs are tested for luminous flux and placed into one of the following bins.

Group Code	Minimum Luminous Flux	Maximum Luminous Flux
S2	2780	2990
S4	2990	3200
T2	3200	3440
T4	3440	3680
U2	3680	3955
U4	3955	4230
V2	4230	4545
V4	4545	4860



**PERFORMANCE GROUPS - CHROMATICITY ( $T_j = 85\text{ }^\circ\text{C}$ )**

XLamp CXB1830 LEDs are tested for chromaticity and placed into one of the regions defined by the following bounding coordinates.

EasyWhite Color Temperatures – 2-Step			
Code	CCT	x	y
40H	4000 K	0.3777	0.3739
		0.3797	0.3816
		0.3861	0.3855
		0.3838	0.3777
35H	3500 K	0.4022	0.3858
		0.4053	0.3942
		0.4125	0.3977
		0.4091	0.3891
30H	3000 K	0.4287	0.3975
		0.4328	0.4064
		0.4390	0.4086
		0.4347	0.3996
27H	2700 K	0.4524	0.4048
		0.4574	0.4140
		0.4633	0.4154
		0.4581	0.4062

EasyWhite Color Temperatures – 3-Step Ellipse						
Bin Code	CCT	Center Point		Major Axis	Minor Axis	Rotation Angle (°)
		x	y	a	b	
50G	5000 K	0.3447	0.3553	0.00840	0.00312	65.0
40G	4000 K	0.3818	0.3797	0.00939	0.00402	53.7
35G	3500 K	0.4073	0.3917	0.00927	0.00414	54.0
30G	3000 K	0.4338	0.4030	0.00834	0.00408	53.2
30Q	3000 K	0.4305	0.3935	0.00834	0.00408	53.2
30U	3000 K	0.4274	0.3837	0.00834	0.00408	53.2
27G	2700 K	0.4577	0.4099	0.00834	0.00420	48.5

EasyWhite Color Temperatures – 5-Step Ellipse						
Bin Code	CCT	Center Point		Major Axis	Minor Axis	Rotation Angle (°)
		x	y	a	b	
65E	6500 K	0.3123	0.3282	0.01110	0.00550	61.0
57E	5700 K	0.3287	0.3417	0.01230	0.00600	72.0
50E	5000 K	0.3447	0.3553	0.01400	0.00520	65.0
40E	4000 K	0.3818	0.3797	0.01565	0.00670	53.7

**CREE EASYWHITE® BINS PLOTTED ON THE 1931 CIE COLOR SPACE ( $T_j = 85\text{ }^\circ\text{C}$ )**

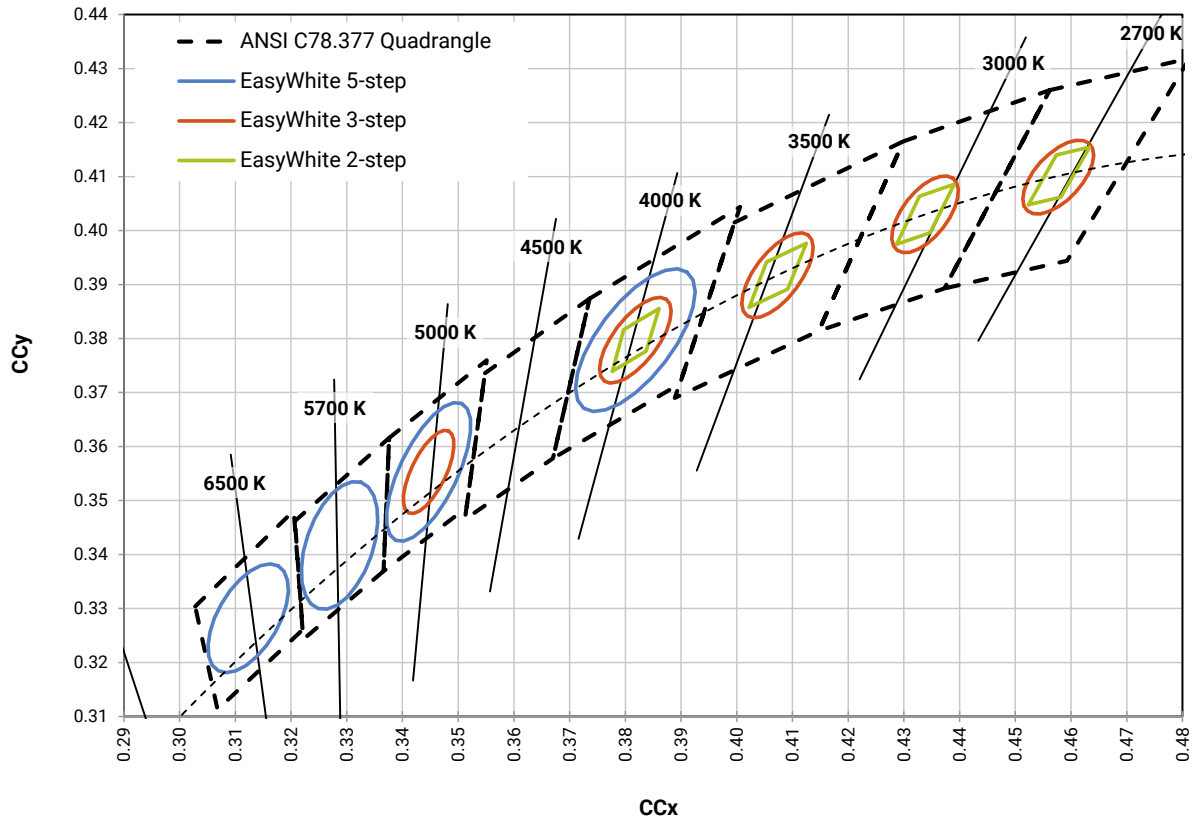

**CREE EASYWHITE® BINS PLOTTED ON THE 1931 CIE COLOR SPACE ( $T_j = 85^\circ\text{C}$ ) - CONTINUED**

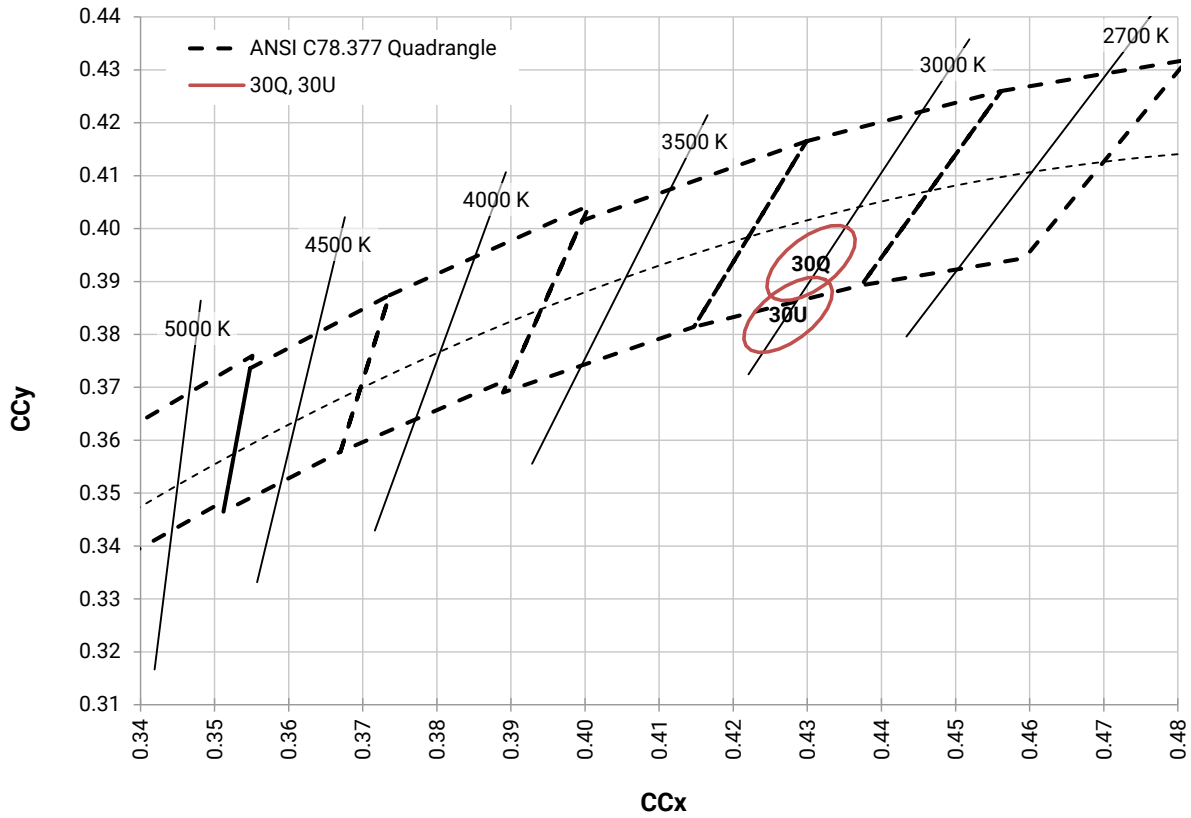



**THERMAL DESIGN**

The CXB family of LED arrays can include over a hundred different LED die inside one package, and thus over a hundred different junction temperatures ( $T_j$ ). Cree has intentionally removed junction-temperature-based operating limits and replaced the commonplace maximum  $T_j$  calculations with maximum ratings based on forward current ( $I_f$ ) and case temperature ( $T_c$ ). No additional calculations are required to ensure the CXB LED is being operated within its designed limits. Please refer to page 2 for the Operating Limit specification.

There is no need to calculate for  $T_j$  inside the package, as the thermal management design process, specifically from solder point ( $T_{sp}$ ) to ambient ( $T_a$ ), remains identical to any other LED component. For more information on thermal management of Cree XLamp LEDs, please refer to the [Thermal Management application note](#). For CXB soldering recommendations and more information on thermal interface materials (TIM) and connection methods, please refer to the [Cree XLamp CX Family LEDs soldering and handling document](#). The [CX Family LED Design Guide](#) provides basic information on the requirements to use Cree XLamp CXB LEDs successfully in luminaire designs.

To keep the CXB1830 LED at or below the maximum rated  $T_c$ , the case to ambient temperature thermal resistance ( $R_{c-a}$ ) must be at or below the maximum  $R_{c-a}$  value shown on the following graph, depending on the operating environment. The y-axis in the graph is a base 10 logarithmic scale.

As the figure at right shows, the  $R_{c-a}$  value is the sum of the thermal resistance of the TIM ( $R_{tim}$ ) plus the thermal resistance of the heat sink ( $R_{hs}$ ).

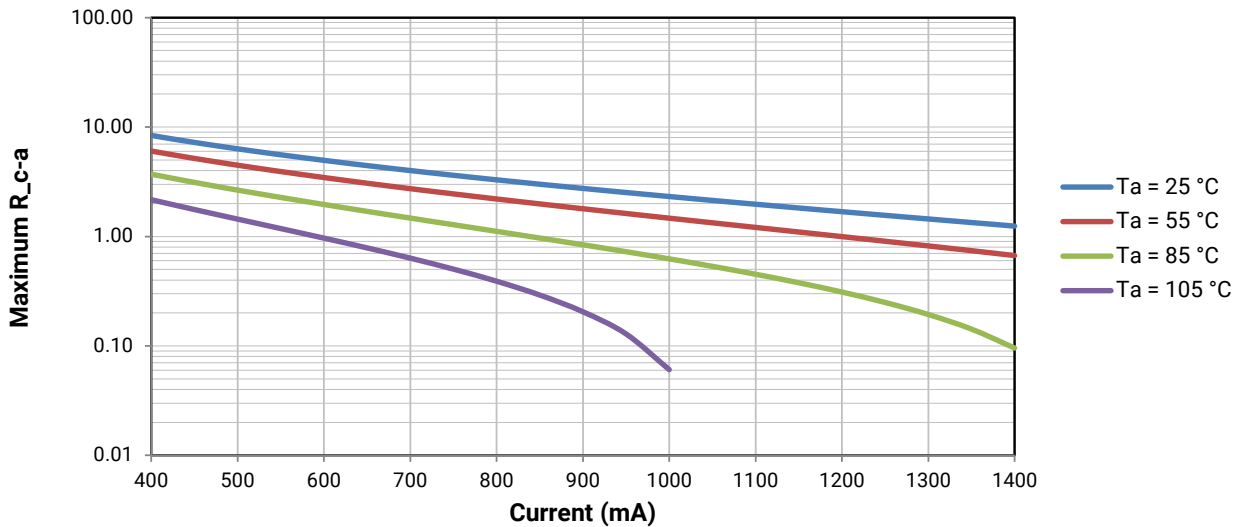
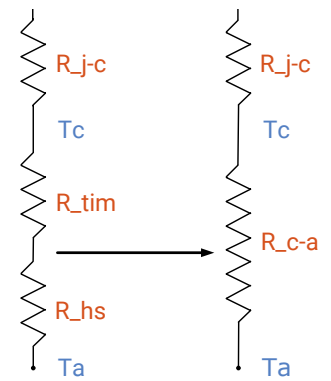

## NOTES

---

### Measurements

The luminous flux, radiant power, chromaticity and CRI measurements in this document are binning specifications only and solely represent product measurements as of the date of shipment. These measurements will change over time based on a number of factors that are not within Cree's control and are not intended or provided as operational specifications for the products. Calculated values are provided for informational purposes only and are not intended as specifications.

### Pre-Release Qualification Testing

Please read the [LED Reliability Overview](#) for details of the qualification process Cree applies to ensure long-term reliability for XLamp LEDs and details of Cree's pre-release qualification testing for XLamp LEDs.

### Lumen Maintenance

Cree now uses standardized IES LM-80-08 and TM-21-11 methods for collecting long-term data and extrapolating LED lumen maintenance. For information on the specific LM-80 data sets available for this LED, refer to the public [LM-80 results document](#).

Please read the [Long-Term Lumen Maintenance application note](#) for more details on Cree's lumen maintenance testing and forecasting. Please read the [Thermal Management application note](#) for details on how thermal design, ambient temperature, and drive current affect the LED junction temperature.

### RoHS Compliance

The levels of RoHS restricted materials in this product are below the maximum concentration values (also referred to as the threshold limits) permitted for such substances, or are used in an exempted application, in accordance with EU Directive 2011/65/EC (RoHS2), as implemented January 2, 2013. RoHS Declarations for this product can be obtained from your Cree representative or from the Product Documentation sections of [www.cree.com](http://www.cree.com).

### REACH Compliance

REACH substances of very high concern (SVHCs) information is available for this product. Since the European Chemical Agency (ECHA) has published notice of their intent to frequently revise the SVHC listing for the foreseeable future, please contact a Cree representative to insure you get the most up-to-date REACH Declaration. REACH banned substance information (REACH Article 67) is also available upon request.

### UL® Recognized Component

Level 4 enclosure consideration. The LED package or a portion thereof has been investigated as a fire and electrical enclosure per ANSI/UL 8750.

### Vision Advisory

WARNING: Do not look at an exposed lamp in operation. Eye injury can result. For more information about LEDs and eye safety, please refer to the [LED Eye Safety application note](#).

**PACKAGING**

Cree CXB1830 LEDs are packaged in trays of 20. Five trays are sealed in an anti-static bag and placed inside a carton, for a total of 100 LEDs per carton. Each carton contains 100 LEDs from the same performance bin.

Dimensions are in inches.  
Tolerances:  $\pm .13$   
 $x^\circ \pm 1^\circ$

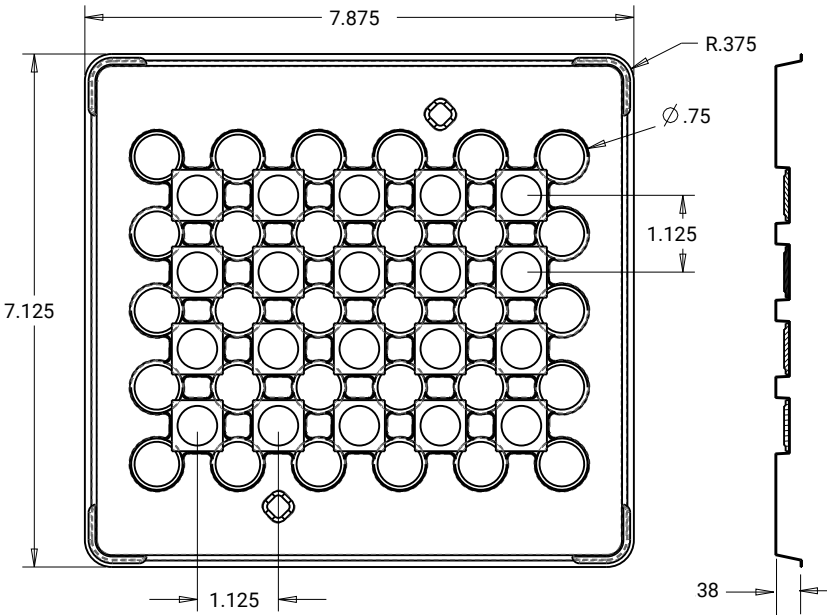

PATENT LABEL IS LOCATED ON UNDERSIDE OF CARTON

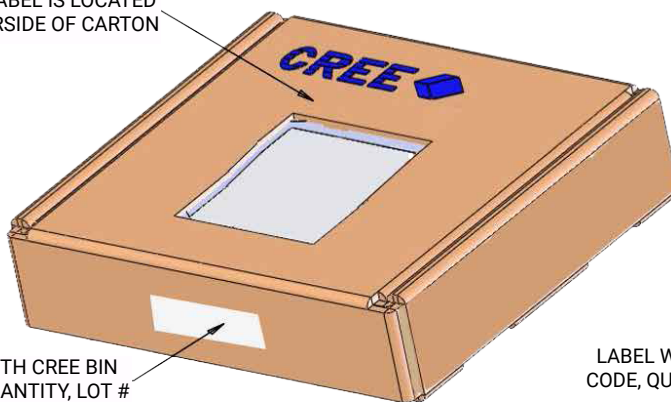

LABEL WITH CREE BIN CODE, QUANTITY, LOT #

BAG

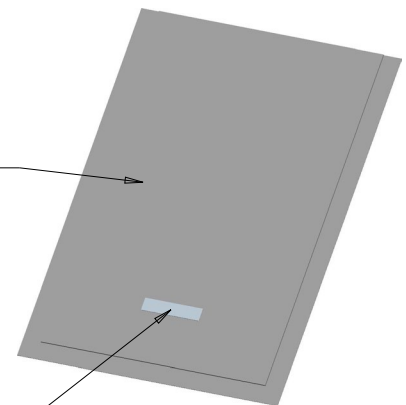

LABEL WITH CREE BIN CODE, QUANTITY, LOT #