



Motion Control AC Inverters VF-0, VF-CE



AV Inverters VF-0, VF-CE

Product Overview

VF-0 Series

- Ultra-compact
- Easy to use
- Cost effective

1-phase 230V AC

- 0.2kW
- 0.4kW
- 0.75kW
- 1.5kW



3-phase 400V AC

- 0.75kW
- 1.5kW
- 2.2kW
- 3.7kW



All 3-phase 400V AC inverters of VF-0 Series are discontinued as of July 31, 2013

VF-CE Series

- Vector control
- Advanced technology
- Filter integrated
- Multiple interfaces (RS232C/RS485, PROFIBUS)

1-phase 230V AC

- 0.25kW
- 0.37kW
- 0.75kW
- 1.5kW
- 2.2kW

3-phase 400V AC

- 0.75kW
 - 1.5kW
 - 2.2kW
 - 4.0kW
- All 3-phase 400V AC inverters of VF-0 Series are discontinued as of July 31, 2013



VF-0 Series

Overview

Highlights

- Ultra-compact
- Easy to operate using the integrated operating panel
- Cost effective
- Easy and accurate frequency control using PLC puls output
- Various types without and with brake included (1-phase)
- 8-speed control function
- Retry function
- Frequency increase, decrease and memory functions using external switches
- Complete regeneration brake function

1-phase 230V AC Input types

MotorPower P _N [kW]	Part No.	
	Brake provided	not provided
0.2		BFV00022DK
0.4	BFV00042GK	BFV00042DK
0.75	BFV00072GK	BFV00072DK
1.5	BFV00152GK	BFV00152DK

3-phase 400V AC Input types

MotorPower P _N [kW]	Part No.
0.75	BFV00074
1.5	BFV00154
2.2	BFV00224
3.7	BFV00374

All 3-phase 400V AC inverters of VF-0 Series are discontinued as of July 31, 2013

Easy to operate

Button to select „frequency output, current display“, „frequency setting, monitor“, „rotation direction setting“, „function setting“ and switching the display to show data or mode

Button to change the display between the parameter No. and data display, and save the data, also to change between frequency and current display

Potentiometer to set the operating frequency



Display shows output frequency, current, line speed, error details, data for function setting and parameter numbers

Button to start the inverter

Button to stop the inverter

Up/Down buttons to change the data and output frequency, and to set forward or reverse run direction

Easy and accurate frequency control with a PLC

Frequency control with a PWM signal from a PLC to the inverter is possible without analogue I/O units. Motor speed can be controlled.

PLC/FPO



PWM signal

VF-0



Motor



VF-0 Series

Specifications

All 3-phase 400V AC inverters of VF-0 Series are discontinued as of July 31, 2013

Input voltage		1-phase 230V AC	3-phase 400V AC
Rated output	Applied motor output	0.2 to 1.5kW	0.75 to 3.7kW
	Rated output voltage	3-phase 200 to 230V AC (proportional to power supply voltage)	3-phase 380 to 460V AC (proportional to power supply voltage)
	Overload current rating	150% of rated output current for 1 minute	
Input power supply	Phases, voltage, frequency	1-phase 200 to 230V AC 50/60Hz	3-phase 380 to 460V AC 50/60Hz
	Tolerable voltage variations	+10%, -15% of rated AC input voltage	
	Tolerable frequency variations	±5% of rated input frequency	
	Instantaneous voltage drop resistance capacity	Continuous operation at 165V or more. Continuous operation at less than 165V for 15ms	Continuous operation at 323V or more. Continuous operation at less than 323V for 15ms
Output frequency	Output frequency range	0.5 to 250Hz	
	Frequency display	Digital display	
	Frequency accuracy	±0.5% of selected maximum set frequency (25±10°C) for analogue setting	
	Frequency setting resolution	Digital setting: 0.1Hz (1Hz over 100Hz), Analogue setting: 0.1Hz (50/60Hz mode)	
Inverter control method		High carrier frequency sinusoidal PWM control (V/F control method)	
Carrier frequency		Select from 9 types (The output current must be reduced for 12.5 and 15.0kHz) (0.8, 1.1, 1.6, 2.5, 5.0, 7.5, 10, 12.5, 15kHz)	Select from 7 types (0.8, 1.1, 1.6, 2.5, 5.0, 7.5, and 10kHz) (The output current of 3.7kW must be reduced when set to 10kHz.)
Operation	Start/Stop	Operation panel buttons or input contact signal (wait time setting possible)	
	Forward/Reverse	Operation panel buttons or input contact signal (reverse rotation prohibit setting possible)	
	Jog operation	Operating frequency: Optional setting for 0.5 to 250Hz. Acceleration/deceleration time: Optional setting each for 0.04 to 999 seconds	
	Stop mode	Select from ramp-to-stop or coast-to-stop (selection changeover)	
	Reset function	Stop signal reset, external reset, panel reset (setting possible) and power supply reset	
	Stop frequency	Optional setting from 0.5 to 60Hz	
	Instantaneous power failure restart	Function OFF, and 0Hz restart, operating frequency restart (selection changeover)	
	Retry function	Retry selection: Select function OFF and details of retry fault, No. of retries: Optional setting for 1 to 10 times	
Control	Frequency setting signal	<ul style="list-style-type: none"> Local setting: Potentiometer, digital setting (operation panel) External analog setting signal: Potentiometer (10kW, 1/4Ω or more), 0 to 5V, 0 to 10V, 4 to 20mA (Connect a 200Ω, 1/4W or more external resistor) External digital setting signal: PWM signal (signal cycle: 0.9 to 1100ms), Frequency up SW, down SW, save SW signal 	
	Voltage/frequency characteristics	Base frequency: 50, 60Hz fixed and optional setting between 45 and 250Hz V/F curve: Constant torque, square torque pattern (selection changeover)	
	2nd voltage/frequency characteristics	Optional base frequency setting for 45 to 250Hz	
	1st and 2nd torque boost level	Optional setting for 0 to 40%	
	1st and 2nd accel./Decel. Time	0.04 to 999sec. (individual accel. and decel. Time setting), Accel./Decel. Characteristics: Linear	
	Multi-speed frequency setting	Up to 8 preset frequency settings (optional setting)	
	Skip frequency setting	Up to 3 place settings (skip frequency band setting from 1 to 10Hz)	
	Upper and lower frequency setting	Optional setting from 0.5 to 250Hz	
	Bias/gain frequency settings	Bias frequency: set from -99 to 250Hz, Gain frequency: set from 0 to 250Hz	
	External stop function	Select from auxiliary stop or coast-to-stop (selection setting)	
Braking	Regenerative braking torque	With brakes	0.4kW, 0.75kW, 1.5kW: 100% or more (short-time) 20% or more
		Without brakes	0.2kW: 100% or more, 0.4kW: 80% or more 0.75kW: 20% or more, 1.5kW: 20% or more 100% or more with connection of brake resistor (option) (built-in brake circuit)
DC braking		Operates when less than stop frequency, Braking torque level: 0 to 100 (set between 20 levels), Braking time: Optional setting for 0.1 to 120 seconds	
Output signal	Analogue output	Output specifications: 0 to 5V (max. 1mA), Output functions: Output frequency, output current proportional (selection changeover)	
	Open collector output	Output specifications: Max. rating 50V DC, 50mA Output functions: Run signal, arrival signal, overload prealarm, frequency detection, reverse run signal, fault warning, output frequency/current proportional PWM signal (cycle 1ms)	
	Relay output	Output specifications: change over (1c) contact (contact capacity 250V AC, 0.5A resistance load) Output functions: Run signal, arrival signal, overload prealarm, frequency detection, reverse run signal, fault warning	
Display	Operating condition	Output frequency or line speed (selection changeover), output current, rotation direction	
	Fault details	Symbol indicated when protective function activates (last 4 faults are stored)	
Protection	Current limit	Current limit can be set from 1 to 200% of rated output current	
	Shut-off (stop)	Instantaneous overcurrent, over temperature (SC1 to 3), overcurrent (OC 1 to 3), overload/electronic thermal overload (OL), low voltage (LV), overvoltage (OU 1 to 3), auxiliary stop (AU), operation error (OP)	
	Stall prevention function	Overcurrent stall prevention, regenerative overvoltage stall prevention	
Environment	Working ambient temperature and humidity	-10°C to +50°C (with no freezing), 90% RH or less (with no dew condensation)	
	Transportation/storage temperature and humidity	-25°C to +65°C, 95% RH or less	
	Altitude and vibration	1000m or less, 5.9m/s (0.6G) or less	
	Atmosphere	Indoors, with no corrosive gases, explosive gases, oil mist or dust present	
Enclosure		IP00	
Cooling method		Self-cooling: 0.2 to 0.75kW, Forced-air cooling: 1.5kW	Self-cooling: 0.75kW, Forced-air cooling: 1.5 to 3.7kW

• Protection against Electric shock: Class I • Overvoltage category: II • Pollution degree: 2

Note: The specifications for the 200V and 400V classes are not the same. Please keep in mind this partial difference.

1a = Normally open

VF-0 Series

Specifications

Dimensions

1-phase 230V AC

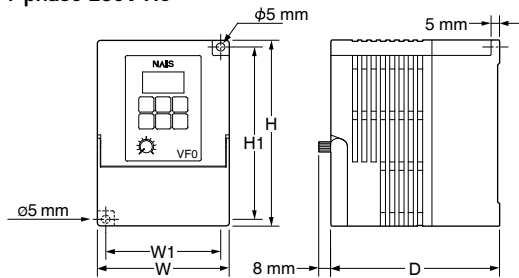

3-phase 400V AC

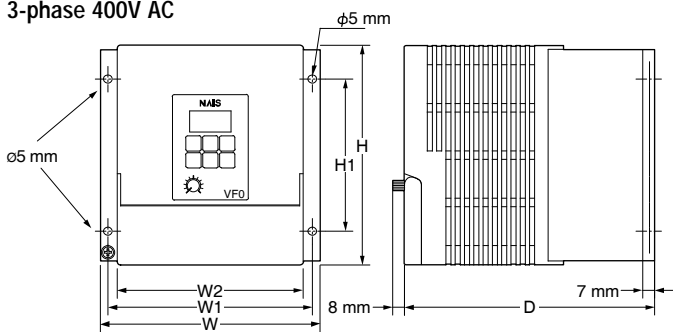

All 3-phase 400V AC inverters of VF-0 Series are discontinued as of July 31, 2013

Part No.	Applicable Motor Capacity [kW]	W [mm]	W1 [mm]	H [mm]	H1 [mm]	D [mm]
BFV00022DK	0.2	78	68	110	102	100
BFV00042DK	0.4					
BFV00042GK	0.4					
BFV00072DK	0.75	100	90	130	121	115
BFV00072GK	0.75					
BFV00152DK	1.5					
BFV00152GK	1.5					

Note 1: 1.5kW includes a cooling fan

Part No.	Inverters Capacity [kW]	W [mm]	W1 [mm]	W2 [mm]	H [mm]	H1 [mm]	D [mm]
BFV00074	0.75	130	121	110	130	90	148
BFV00154	1.5	130	121	110	130	90	161
BFV00224	2.2						
BFV000334	3.7	160	151	140	130	90	161

Note 1: 1.5 to 3.7kW includes a cooling fan

Brake resistor

VF-0 Part No.	Motor [kW]	Brake resistor Part No.	Dimensions [mm]
BFV00074	0.75kW 3-phase 400V	BFVC9164U	110 x 80 x 15
BFV00154	1.5kW 3-phase 400V	BFVC9164U	110 x 80 x 15
BFV00224	2.2kW 3-phase 400V	BFVC9165U	110 x 80 x 15
BFV00374	3.7kW 3-phase 400V	BFVC9166U	216 x 80 x 15



For 1-phase 230 V AC types please select the BFV00042GK, BFV00072GK or BFV00152GK. The brake resistor is either enclosed, or built in.

Filters

EMC filters are usually employed to reduce conducted disturbances and thus ensure constant quality in the power supply network.

For use, the standards EN61800-3 (product standard) and EN55011/EN55022 (limits and methods of measurement) are important, whereby the following limits must be met: EN55011/EN55022, Class A: Limits for general industrial use. This applies to all usage sites that are normally connected to their own individual high- of medium-high voltage transformer.

Inverter	P _N	EMC Filter	Compliant to	Part No.
VF-0 1-phase	0.2kW – 1.5kW	200V type	EN55022 Class A and B	FN2071N606
VF-0 3-phase	0.75kW – 3.7kW	400V type	EN55022 Class A and B	FN3258745

VF-CE Series

Overview

For the 0.25kW to 4.0kW power range

- Ultra-compact
 - Integrated filter with EMC interference to class B
 - Vector control and V/f control
 - Up to $1.8 \times M_N$ torque for 60s (M_N = rated load torque)
 - Multiple interfaces (digital/analog I/O, RS232/RS485, PROFIBUS)
 - Operator module with copy function
 - International approvals (CE, UL, cUL)
 - Cost effective
 - Energy efficient
 - Types: 1-phase 230V AC: 0.25 to 2.2kW
(1-phase 115V AC power supply also possible with restrictions)
 - 3-phase 400V AC: 0.75 to 4.0kW
(3-phase 200V AC power supply also possible with restrictions)
- All 3-phase 400V AC inverters of VF-0 Series are discontinued as of July 31, 2013

Available Communication I/O modules

For Automation interface AIF



BFVC904C
Keypad



BFVC9503
RS232C/RS485
Communication
module



BFVC9901
PROFIBUS AIF
DP slave
interface

System units

For Function interface FIF



BFVC90XY
Standard I/O Modul
(always included)
with digital and
analogue I/O



BFVC9902
PROFIBUS
DP slave interface FIF

FIF



AIF



For detailed description of the modules see page 8/9.

VF-CE Series

Specifications

Improved vector control increases efficiency

Due to vector control, the VF-CE inverter achieves considerably higher torque in comparison to conventional V/f control (maximum torque = 1.8 x M_N for 60s) and has low level open-circuit power consumption. This function is particularly useful for drives with strong fluctuating loads or high starting inertia, as well as for sensorless speed control of motors requiring slip compensation.

Integrated EMC filter to class B – new for VF-CE inverters

VF-CE inverters offer a new concept for preventing electrical interference. For the first time ever, the EMC filters are not connected externally in series. Since many small EMC components are located at the points on the printed circuit board where interference is actually generated, it can be prevented right at the source. The result is a higher filter performance, lower costs and a VF-CE inverters even more compact than before.

Performance	Part No.	Supply Voltage (45 – 65Hz)	Supply Voltage (1 ~ 115V AC / 3 ~ 200V AC)	Power P_N for USA	Dimensions (H x W x D) in mm
1-phase 230V AC:					
0.25kW	BFVCE0022A	1 ~ 180 – 264V AC	1 ~ 115V AC: 0.12kW	0.16HP	120 x 60 x 140
0.37kW	BFVCE0032A	1 ~ 180 – 264V AC	1 ~ 115V AC: 0.18kW	0.24HP	120 x 60 x 140
0.75kW	BFVCE0072A	1 ~ 180 – 264V AC	3 ~ 200V AC: 0.75kW	1HP	180 x 60 x 140
1.5kW	BFVCE0152A	1 ~ 180 – 264V AC	3 ~ 200V AC: 1.5kW	2HP	240 x 60 x 140
2.2kW	BFVCE0222A	1 ~ 180 – 264V AC	3 ~ 200V AC: 2.2kW	3HP	240 x 60 x 140
3-phase 400V AC: All 3-phase 400V AC inverters of VF-0 Series are discontinued as of July 31, 2013					
0.75kW	BFVCE0074A	3 ~ 320 – 550V AC		1HP	180 x 60 x 140
1.5kW	BFVCE0154A	3 ~ 320 – 550V AC		2HP	240 x 60 x 140
2.2kW	BFVCE0224A	3 ~ 320 – 550V AC		3HP	240 x 60 x 140
4.0kW	BFVCE0404A	3 ~ 320 – 550V AC		5.4HP	240 x 100 x 140

Other types available on demand

Accessories / Interfaces

Type	Description	Part No.
Operator module	for entering the parameters; with copy function	BFVC 904C
Remote control set with operator module	for flexible manual operation with cable connection	BFVC 9060
2m cable for remote control set		BFVC 9062
5m cable for remote control set		BFVC 9065
Standard I/O module	digital and analogue inputs/outputs (always included)	BFVC 90XY
RS232C / RS485 communication module	RS232C and RS485 (multi-drop) for connection to computer or PLC	BFVC 9503
Cable RS232C to PC-AT	Connection cable between VF-CE RS232C port and computer RS232C port	BFVC 9503 PCAT
Cable RS232C to PLC	Connection cable between VF-CE RS232C port and PLC RS232C port, SUB-D 9pin	BFVC 9503 PLC
PROFIBUS AIF module	PROFIBUS interface for connection on AIF	BFVC 9901
PROFIBUS FIF module	PROFIBUS interface for connection on FIF	BFVC 9902
Braking resistors	for 1-phase 0.75kW – 1.5kW inverter *)	BFVC 9161U
	for 1-phase 2.2kW inverter	BFVC 9162U
	for 3-phase 0.75kW – 1.5kW inverter	BFVC 9164U
	for 3-phase 2.2kW inverter	BFVC 9165U
	for 3-phase 4.0kW inverter	BFVC 9166U
Swiveling mounting bracket	for side mounting of 1.5 and 2.2kW inverter	BFVC 9999
Motion Control Software Ver. 2.0	Inverter configurator software for the inverters and VF-CE	BFVS 29902V2

*) 0.25/0.37kW brake resistor on request

VF-CE Series

The VF-CE inverter's interfaces

1. The standard I/O module

It provides parallel, direct connection of peripherals such as PLC, sensors, etc. and offers a variety of connection possibilities.

	Number	Voltage	Current	Resolution
Analogue input	1	0 ... 10V -10 ... +10V	0/4 ... 20mA	10bits 10bits
Analogue output	1	0 ... 10V	2mA	10bits
Digital inputs	3/4	PLC level		
Frequency input	1/0 (0 ... 10kHz)	0/15V (HTL)		
Digital output	1	0/24V	10/50mA	

One relay output (changeover contact) is integrated into the system unit as standard.
(AC 240V/3A, DC 24V/2A ... 200V/0.18A)

Standard I/O module
BFVC90XY



The standard I/O module order number BFVC 90XY is included in the VF-CE inverter. It needs not be ordered separately.

2. The RS232C / RS485 communication module

Two serial interfaces allow the VF-CE inverter to communicate with the application device and have its parameters adjusted by a controller simultaneously.

RS232C interface:

- Information message format: 7 bits ASCII, 1 stop bit, 1 start bit, 1 parity bit (even)
- Bit rate: 1.2 / 2.4 / 4.8 / 9.6 / 19.2 kBaud
- Access to all parameters
- DC supply: internal (5V)
- Electric isolation from control/power section

RS485 interface:

- Information message format: 7 bits ASCII, 1 stop bit, 1 start bit, 1 parity bit (even)
- Bit rate: 1.2 / 2.4 / 4.8 / 9.6 / 19.2 kBaud
- Max. distance between 2 stations: 1200m
- Number of stations: max. 90 (with repeater)
- DC supply: internal

RS232C/RS485
communication interface
BFVC9503



3. The PROFIBUS modules

Two different PROFIBUS modules permit open communication in accordance with the international EN50170 standard. The PROFIBUS FIF module is used instead of the standard I/O module. If the standard I/O module is necessary in the application, the PROFIBUS AIF module can be used as the automation interface.

- Bit rate: 9.6 kBaud ... 12 MBaud (automatic detection)
- Max. cable length: 1.2km (depends on baud rate and cable)
- Number of stations: 32 (with repeater 125)
- PROFIBUS status: Slave
- Communication profile: PROFIBUS-DP (DIN 19245, parts 1 and 3)
- Drive profile: DRIVECOM Profile 20
- Access to all parameters

Profibus Interface AIF
BFVC9901



Profibus Interface FIF
BFVC9902



VF-CE Series

Operator module

The VF-CE inverter operator module keypad

The operator module allows you to enter or change the VF-CE parameters as well as display the current drive parameters. The VF-CE parameters can be saved in the operator module (BFVC904C) and simply copied to another VF-CE inverter. Time-consuming parameter setting for larger applications is therefore no longer required and errors are reduced accordingly. The VF-CE inverter operator module can be directly plugged into the VF-CE AIF interface or operated as a remote control set with a 2m or 5m cable. The remote-control set can also be installed in control cabinets and operator consoles.

The operator module is not included in the VF-CE inverter. It is available as an option.

Key functions of the operating module:



Enable inverter

Inhibit inverter or quick-stop



Change to function bar 1 ↔ function bar 2



To right/left in an active function bar



Increase/decrease value



Store Parameter/Acknowledgement



Operator module keypad
BFVC904C

The remote control set with operator module

The operator module (BFVC904C) is already integrated. The 2m or 5m cables are supplied separately (Part No. see below).

Hand terminal

To comfortably operate the VF-CE inverters via the hand-held terminal, a protective rubber holder is included.

The keypad also allows for remote programming if the inverter is not easily accessible.



Front panel mounting

After removing the protective rubber holder from the remote control set, the keypad can be mounted in switch-gear cabinets and operator consoles. (cut-out 45.3 x 45.3mm).

- 1 Baseplate
- 2 Seal
- 3 Keypad
- 4 Screw 0.7Nm
- 5 Control cabinet sheet thickness 0.5mm - 1.5mm

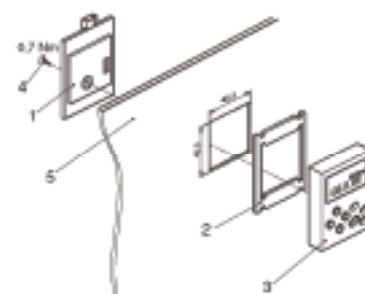

Available cables

Part No.	Length
BFVC9062	2m
BFVC9065	5m

VF-CE Series

Specifications

Control method	V/f control (linear, square), vector control
Operating frequency	Either 2kHz, 4kHz, 8kHz, 16kHz
Maximum torque	1.8 x M _N for 60s, if motor rated power = inverter rated power
Torque speed range	1 : 10 (3 ... 50Hz, constant speed)
Sensorless speed control	Min. output frequency 1.0Hz (0 ... M _N) sensorless speed control Speed range 1 : 50 (based on 50Hz) Accuracy 0.5% 3 ... 50Hz Smooth running ±0.1Hz 3 ... 50Hz
Generator operation (monitored internally)	Integrated braking transistor
Filter	Integrated as standard-class B
Skip frequencies	Up to 3 skip frequencies can be set to avoid resonance
Other standard features	Motor parameter adaptation and correction, thermo-couple input for monitoring motor temperature, 1ms terminal sampling time, linear and S-ramp, fixed speeds, four parameter programs can be switched online, bipolar set-point processing.

General technical data/Operating conditions

Resistance to vibration	Acceleration resistance up to 0.7g (Germanischer Lloyd, general conditions)	
Permissible temperature ranges	Transport	-25°C ... +70°C
	Storage	-25°C ... +60°C
	Operation	-10°C ... +55°C above +40°C the rated output current is to be reduced by 2.5%/°C
Permissible installation height	0 ... 4000m amsl	above 1000m amsl the rated output current is to be reduced by 5%/1000m
Mounting position	Vertical	
Protective measures against	Short-circuit, ground fault, over-voltage, motor becoming unstable, motor overheating (input for thermo-couple)	
Total insulation against control-circuits	Safe separation from mains, double basic insulation in accordance with EN 50178	
Degree of protection	IP20	
Conformity	CE low-voltage guideline (73/23/EEC)	
Emitted interference	Requirements as per EN 50081-1	
	Limiting value class A as per EN 55011	
	Limiting value class B as per EN 55022	
Interference immunity	Requirements as per EN 61800-3 immunity to interference	
	Requirements	Standard Severity
	ESD	EN 61000-4-2 3, i.e. 8kV with air discharge 6kV with contact discharge
	HF irradiation (casing)	EN 61000-4-3 3, i.e. 10V/m; 27 ... 1000MHz
	Colour burst	EN 61000-4-4 3/4, i.e. 2kV/5kHz
Surge	EN 61000-4-5 3, i.e. 1,2/50µs, 1kV phase-phase, 2kV phase-PE	
Insulation resistance	Over-voltage category III in accordance with VDE 0110	
Approvals	UL 508	Industrial Control Equipment
	UL 508C	Power Conversion Equipment

VF-CE Series

Specifications

1-phase 230V AC

Typical Motor Power 3-phase asynchronous motor (4-pole)	P_r [kW] P_r [hp]	0.25 0.34	0.37 0.5	0.75 1.0	1.5 2.0	2.2 3.0			
VF-CE type	EMC filter integrated	BFVCE0022A	BFVCE0032A	BFVCE0072A	BFVCE0152A	BFVCE0222A			
Mains voltage	U_{mains} [V]	1/N/PE AC 180V - 0 % ... 264V + 0 % ; 45 Hz - 0 % ... 65 Hz + 0 %		1/N/PE AC 180 V - 0 % ... 264 V + 0 % ; 45 Hz - 0 % ... 65 Hz + 0 % 3/PE AC 100 V - 0% ... 264 V + 0%; 45 Hz - 0% --- 65 Hz + 0%					
Alternative DC supply	U_{DC} [V]	not possible		DC 140 V - 0% ... 370 V + 0%					
Data for operation with 1/N/PE or 3/PE		1/N/PE	1/N/PE	1/N/PE	3/PE	1/N/PE	3/PE	1/N/PE ⁵⁾	3/PE
Rated mains current									
without mains choke	I_{mains} [A]	3.4	5.0	9.0	5.2	15.0	9.1	–	12.4
with mains choke	I_{mains} [A]	3.0	4.2	7.5	3.6	12.5	6.3	18.0	9.0
Output power U, V, W	S_r [kVA]	0.68	1.0	1.6		2.8		3.8	
Output power +UG, -UG ¹⁾	P_{DC} [kW]	DC bus operation not possible		–	0.1	–	1.1	–	0.4
Rated output current at chopper frequency	2kHz sin	I_R [A] ⁴⁾	1.7	2.4	4.0	7.0	9.5		
	4kHz sin								
	8kHz sin								
	16kHz sin ³⁾								
Max. permissible output current for 60s at chopper frequency ²⁾	2kHz sin	I_{max} [A]	2.5	3.6	6.0	10.5	14.2		
	4kHz sin								
	8kHz sin								
	16kHz sin ³⁾								
Output voltage									
without mains choke	U_M [V]	3- 0 ... V_{mains} / 0 ... 650Hz							
with mains choke	U_M [V]	3- 0 ... approx. 94% U_{mains} / 0 ... 650Hz							
Power loss (operation with I_R)	UP_V [W]	30	40	60		100		130	
Required mains choke ⁴⁾									
Rated currents Inductance	I_N [A]	–	–	–		–		18.0	–
	[mH]	–	–	–		–		2.5	–
Dimensions	H x W x D [mm]	120 x 60 x 140	120 x 60 x 140	180 x 60 x 140		240 x 60 x 140		240 x 60 x 140	
Weight	m [kg]	0.8	0.8	1.2		1.6		1.6	

Printed in bold = Data for operation at 8kHz chopper frequency (default setting)

- 1) For operation with power-adapted motors additional power to be taken from the DC bus
- 2) Currents for periodic load change: 1min overcurrent with I_{max} and 2min basic load with 75 % I_r
- 3) Chopper frequency is reduced to 4kHz if ϑ_{max} reaches - 5°C
- 4) Possible for other types with different application conditions: Operation with increased rated output current and the same load change
- 5) Operation only with mains choke
- 6) Select the mains choke for an overcurrent of 160% for at least 60s

VF-CE Series

Specifications

3-phase 400V AC All 3-phase 400V AC inverters of VF-0 Series are discontinued as of July 31, 2013

Typical Motor Power Three-phase asynchronous motor (4-pole)	P_r [kW] P_r [hp]	0.75 1.0	1.5 2.0	2.2 3.0	4.0 40
VF-CE type	EMC filter integrated	BFVCE0074A ⁵⁾	BFVCE0154A ⁵⁾	BFVCE0224A ⁵⁾	BFVCE0404A
Mains voltage	U_{mains} [V]	3/PE AC 320 V - 0 % ... 550 V + 0 % ; 45 Hz - 0 % ... 65 Hz + 0 %			
Alternative DC supply	U_{DC} [V]	DC 450 V - 0 % ... 775 V + 0 %			

Data for operation with 3/PE AC 400V or DV 565 V

Rated mains current without mains choke	I_{mains} [A]	3.3	5.5	7.3	12.3	
with mains choke	I_{mains} [A]	2.3	3.9	5.1	8.8	
Output power U, V, W	S_r [kVA]	1.7	2.7	3.9	6.6	
Output power +UG, -UG ¹⁾	P_{DC} [kW]	0.1	1.1	0.4	0.8	
Rated output current at chopper frequency	2kHz sin 4kHz sin	I_R [A] ⁴⁾	2.4	4.7	5.6	9.5
	8kHz sin					
	16kHz sin ³⁾	I_R [A]	1.6	2.5	3.6	6.1
	Max. permissible output current for 60 s at chopper frequency ²⁾	2kHz sin 4kHz sin	I_{max} [A]	3.6	5.9	8.4
8kHz sin		3.6				
16kHz sin ³⁾		I_R [A]	2.4	3.8	5.5	9.1
Output voltage without mains choke		U_M [V]	3- 0 ... V_{mains} / 0 ... 650 Hz			
with mains choke	U_M [V]	3- 0 ... approx. 94 % U_{mains} / 0 ... 650 Hz				
Power loss (operation with I_R)	P_V [W]	60	100	130	180	
Required mains choke	-	-	-	-	-	
Required brake resistor ⁵⁾	Type	BFVC9164U		BFVC9165U	-	
Dimensions	H x W x D [mm]	180x60x140	240x60x140	240x60x140	240x100x140	
Weight	m [kg]	1.2	1.6	1.6	2.9	

Printed in bold = Data for operation at 8kHz chopper frequency (default setting)

- For operation with power-adapted motors additional power to be taken from the DC bus
- Currents for periodic load change: 1min overcurrent with I_{max} and 2 min basic load with 75% I_r

3) Chopper frequency is reduced to 4kHz if ϑ_{max} reaches - 5°C

- Possible for other types with different application conditions:
Operation with increased rated output current and the same load change
- Operation at mains voltages 484 V - 0%... 550V + 0% is only permissible with break resistor!

Manuals

Order Number	Manual Information	Paper	PDF
ARCT1F328E	Compact Inverter VF-0 Series (1-phase, 200V) Instruction Manual		x
ARCT1F351E	Compact Inverter VF-0 Series (3-phase, 200V) Instruction Manual		x
ACGM0180V20EN	Inverter VF-CE COMPACT Operating Instructions	x	
ACGM0181END	VF-CE Inverter RS232C/RS485 Communication Module Technical Specifications	x	x
ACGM0184END	Inverter VF-CE Compact Easy User's Guide	x	x
ACGM0182END	VF-CE Inverter PROFIBUS AIF Module DP Slave Operating Instructions	x	x
ACGM0183V20EN	VF-CE Inverter PROFIBUS FIF Module DP Slave Operating Instructions	x	x
VFO Leaflet V11EN	EMC Guidelines for the VF-0 Series Inverter		x

Paper versions can be ordered with the above product number.

PDF versions can be downloaded from the internet free of charge: www.panasonic-electric-works.com, section motion control/inverters/manual download
(New users have to register first).

VF-CE Series

Dimensions

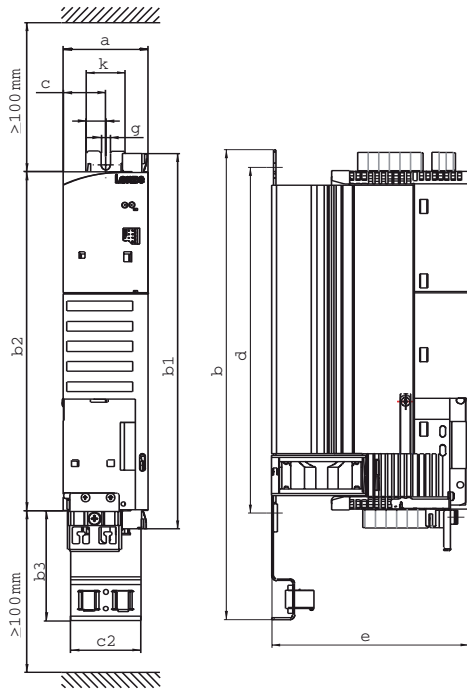

Dimensions in mm	BFVCE0022A BFVCE0032A	BFVCE007xA	BFVCE015xA ¹⁾ BFVCE022xA ¹⁾
a	60		
b ³⁾	213/243/263	273/303/323	333/359 ²⁾ /363
b1	148	208	268
b2	120	180	240
b3	78		
c	30		
c1	63		
c2	50		
c3	130...140/ 120...170/ 110...200/	190...200/ 180...230/ 170...260	250...260/ 280...295 ²⁾ / 240...290
e	140	140	100/162 ²⁾
g	6.5		
k	28		

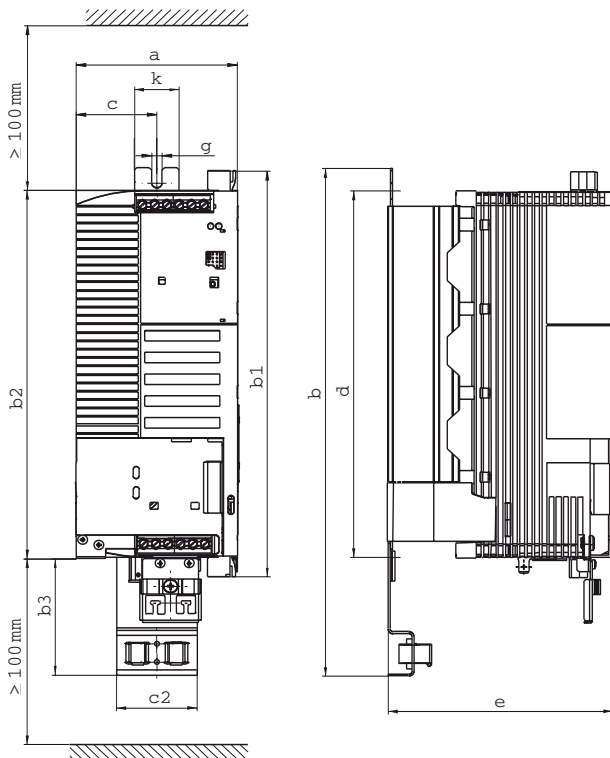

BFVCE0404A	
a	100mm
b	333mm
b1	268mm
b2	240mm
b3	78mm
c	50mm
c1	103mm
c2	50mm
d	255mm
e	140mm
g	6.5mm
k	28mm

- 1) Lateral Mounting only possible with swivel mounting unit BFVE9999
 2) with BFVCE9999
 3) different sizes depend on way of mounting using the Fixing Rails

Software

Motion Control Ver. 2.0

The configuration software for Panasonic inverters

Motion Control is the parameter setting software from Panasonic that allows for integrated communication with all inverters which are equipped with RS232C or RS485 serial communication interfaces, including the Panasonic inverters VF-CE, VF-8E and VF-8X.

Functionality

- Parameter entry
- Test operation (Start/Stop, Forward/Reverse, Acceleration/Deceleration, etc.)
- Saving and documenting settings
- Automatic drive selector
- Quick launch window
- Project navigator
- Status monitor
- Fault screen

Motion Control system requirements:

- Personal computer with min. 486DX4 100MHz processor and 8MB RAM (better Pentium 133MHz, 16MB RAM)
- Video card with 640x480 resolution (better 800x600)
- MS Windows 95®/98®/2000/MS Windows NT®/Windows XP
- Inverter VF-CE, VF-8E or VF-8X

The Quick Launch Window

The Quick Launch Window is the starting point for the configuration environment.

It supplies the necessary tools for:

- Creating new projects or opening projects from archives
- Setting up and establishing communication with the drive(s)
- Monitoring a drive's operation
- Sending commands to a drive
- Providing on-line help



Project Navigator

Project Navigator is the active project management window. By double-clicking on the tree branches, it is possible to:

- Have access to the communication settings in order to establish communication with the drive(s)
- Have access to edit the parameters (parameters are grouped by common theme)
- Make one's own parameter groups with the PUG Wizard (Parameter User Groups) based on application/user needs

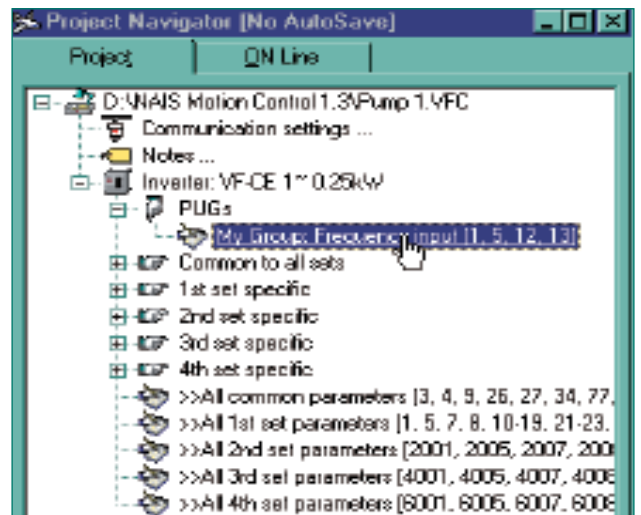

Software

Motion Control Ver. 2.0

Editing Parameters

The Parameter Edit windows display common groups of parameters with the default values that pertain to the selected drive. From these windows it is possible to:

- Edit the drive(s) parameters
- Upload into one or more drives or download a set of parameters from a drive
- Start a comparison between the current project and the drive, or between two drives regarding the currently selected parameters

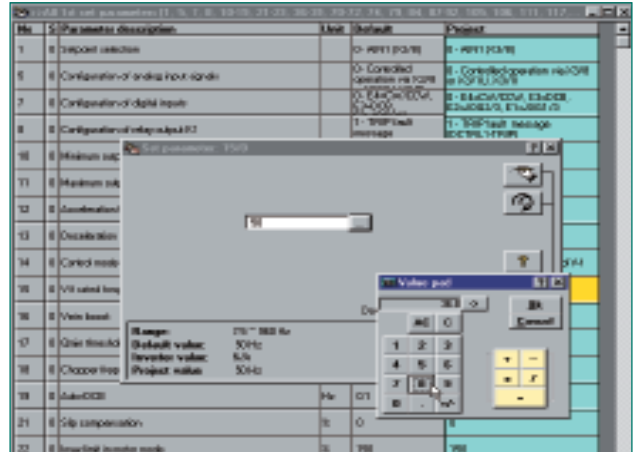

Trend Window

The real-time trend graphs provide constantly updated and easy-to-interpret snapshots of drive operation. They immediately show the relationship between output frequency, voltage, and current, which can be very helpful in confirming proper operation and in troubleshooting performance problems. Further parameters and values can be selected.

The Trend Window can be opened by an icon on the toolbar.

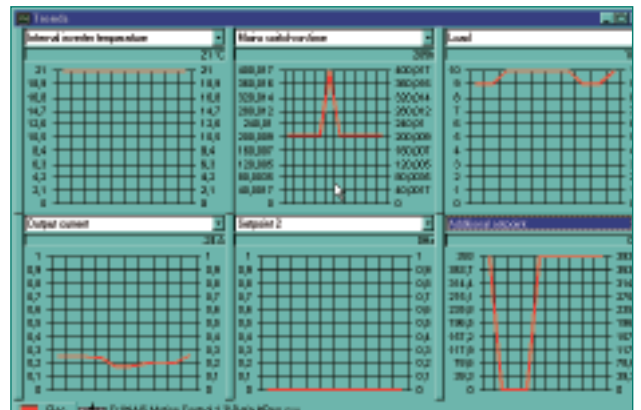

Command Panel

The Command Panel allows direct control of the drive from the configuration software. From here it is possible to:

- Start and stop the drive
- Change motor direction from forward to reverse
- Control the drive's frequency setting by drag-rotation of the speed dial with the mouse pointer or by directly entering a value in the frequency display field
- Set/reset important parameters

The Command Window can be opened by an icon on the toolbar

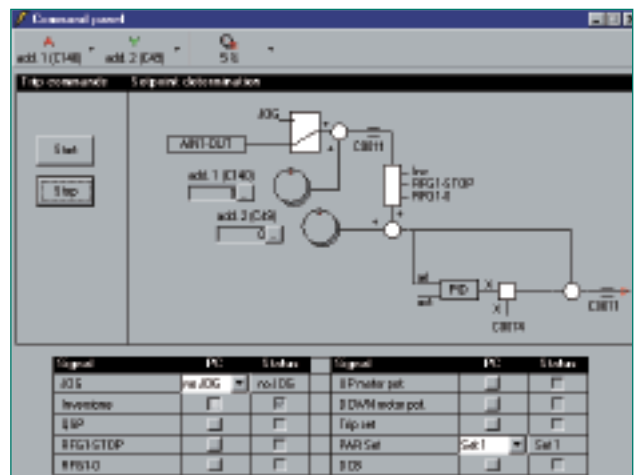

User Library for Control FWIN Pro

This library offers 20 function blocks that control the inverter series VF-CE (also the older VF-8E/8X series) via serial interfaces in the PLCs (RS232C, RS485). Typical functions include:

Starting/stopping the inverter, changing rotation direction, changing the set-point frequency, reading status information, writing parameters, etc., without detailed knowledge of the internal inverter. Product-Number: **NCL-ISC-LIBD**

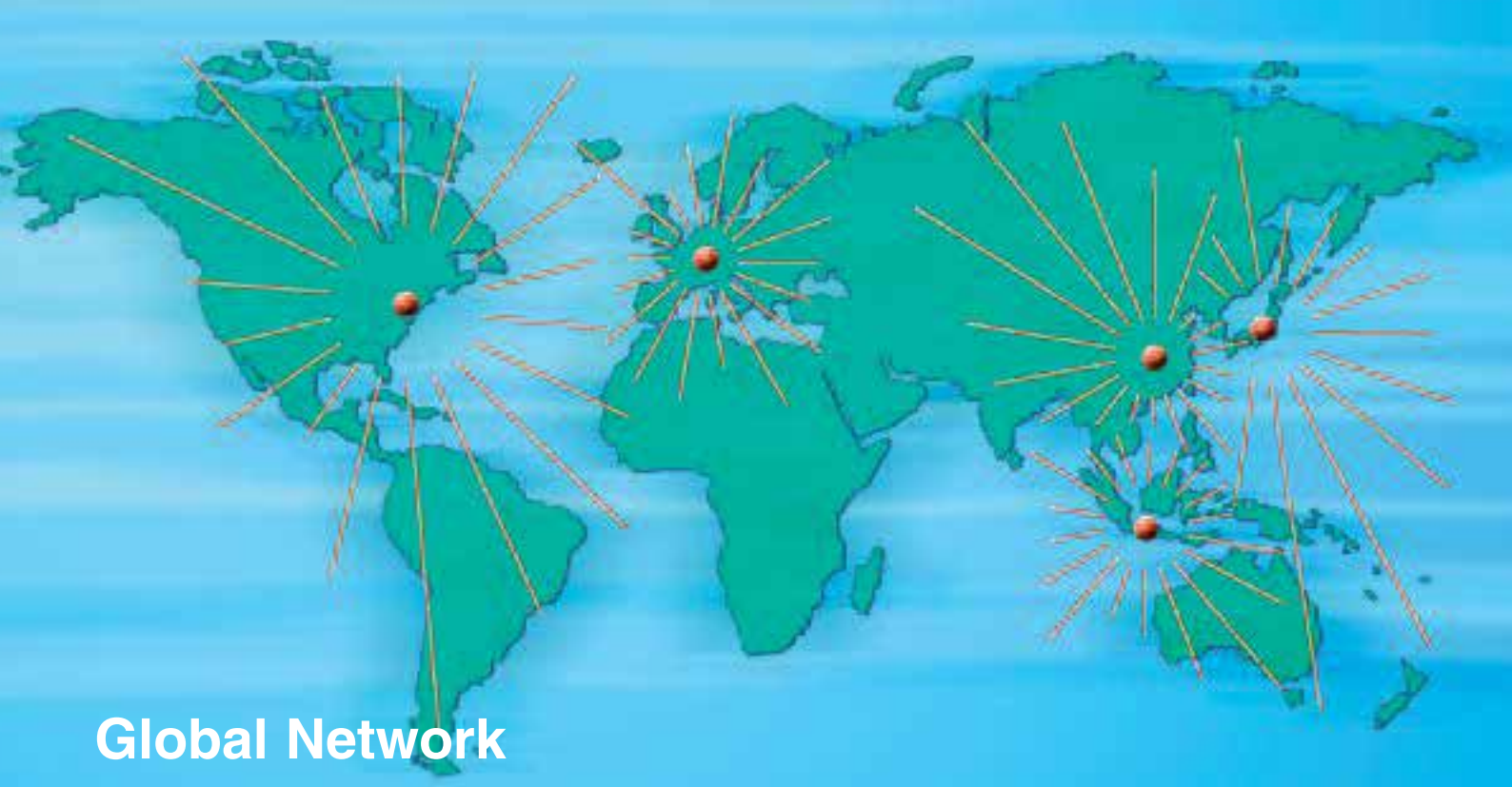

Global Network

North America

Europe

Asia Pacific

China

Japan

Panasonic Electric Works

Please contact our Global Sales Companies in:

Europe		
▶ Headquarters	Panasonic Electric Works Europe AG	Rudolf-Diesel-Ring 2, 83607 Holzkirchen, Tel. (08024) 648-0, Fax (08024) 648-111, www.panasonic-electric-works.com
▶ Austria	Panasonic Electric Works Austria GmbH	Josef Madersperger Str. 2, 2362 Biedermannsdorf, Tel. (022 36) 2 68 46, Fax (022 36) 4 61 33, www.panasonic-electric-works.at
	PEW Electronic Materials Europe GmbH	Ennshafenstraße 30, 4470 Enns, Tel. (072 23) 8 83, Fax (072 23) 8 83 33, www.panasonic-electronic-materials.com
▶ Benelux	Panasonic Electric Works Sales Western Europe B.V.	De Rijn 4, (Postbus 211), 5684 PJ Best, (5680 AE Best), Netherlands, Tel. (0499) 372727, Fax (0499) 372185, www.panasonic-electric-works.nl
▶ Czech Republic	Panasonic Electric Works Czech s.r.o.	Prumyslová 1, 34815 Plana, Tel. 374 799 990, Fax 374 799 999, www.panasonic-electric-works.cz
▶ France	Panasonic Electric Works Sales Western Europe B.V.	French Branch Office, B.P. 44, 91371 Verrières le Buisson CEDEX, Tel. 01 60135757, Fax 01 60135758, www.panasonic-electric-works.fr
	PEW Electronic Materials France S.A.R.L.	26 Allée du Clos des Charmes, 77090 Collegien, Tel. 01 64622919, Fax 01 64622809, www.panasonic-electronic-materials.com
▶ Germany	Panasonic Electric Works Deutschland GmbH	Rudolf-Diesel-Ring 2, 83607 Holzkirchen, Tel. (08024) 648-0, Fax (08024) 648-555, www.panasonic-electric-works.de
▶ Ireland	Panasonic Electric Works UK Ltd.	Dublin, Tel. (01) 4600969, Fax (01) 4601131, www.panasonic-electric-works.co.uk
▶ Italy	Panasonic Electric Works Italia s.r.l.	Via del Commercio 3-5 (Z.I. Ferlina), 37012 Bussolengo (VR), Tel. (045) 6752711, Fax (045) 6700444, www.panasonic-electric-works.it
	PEW Building Materials Europe s.r.l.	Viale Elvezia 18, 20154 Milano (MI), Tel. (02) 33604525, Fax (02) 33605053, www.panasonic-building-materials.com
▶ Nordic Countries	Panasonic Electric Works Nordic AB	Sjöängsvägen 10, 19272 Sollentuna, Sweden, Tel. (08) 59476680, Fax (08) 59476690, www.panasonic-electric-works.se
	PEW Fire & Security Technology Europe AB	Citadellsvägen 23, 21118 Malmö, Tel. (040) 6977000, Fax (040) 6977099, www.panasonic-fire-security.com
▶ Portugal	Panasonic Electric Works España S.A.	Portuguese Branch Office, Avda Adelino Amaro da Costa 728 R/C J, 2750-277 Cascais, Tel. (21) 4812520, Fax (21) 4812529
▶ Spain	Panasonic Electric Works España S.A.	Barajas Park, San Severo 20, 28042 Madrid, Tel. (91) 3293875, Fax (91) 3292976, www.panasonic-electric-works.es
▶ Switzerland	Panasonic Electric Works Schweiz AG	Grundstrasse 8, 6343 Rotkreuz, Tel. (041) 7997050, Fax (041) 7997055, www.panasonic-electric-works.ch
▶ United Kingdom	Panasonic Electric Works UK Ltd.	Sunrise Parkway, Linford Wood, Milton Keynes, MK14 6LF, Tel. (01908) 231555, Fax (01908) 231599, www.panasonic-electric-works.co.uk
North & South America		
▶ USA	PEW Corporation of America Head Office USA	629 Central Avenue, New Providence, N.J. 07974, Tel. 1-908-464-3550, Fax 1-908-464-8513, www.pewa.panasonic.com
Asia Pacific / China / Japan		
▶ China	Matsushita Electric Works (China) Co., Ltd.	2013, Beijing Fortune, Building No. 5, Dong San Huan Bei Lu, Chaoyang District, Beijing, Tel. (010) 6590-8646, Fax (010) 6590-8647
▶ Hong Kong	Panasonic Electric Works (Hong Kong) Co., Ltd.	Rm1601, 16/F, Tower 2, The Gateway, 25 Canton Road, Tsimshatsui, Kowloon, Hong Kong, Tel. (0852) 2956-3118, Fax (0852) 2956-0398
▶ Japan	Matsushita Electric Works, Ltd.	1048 Kadoma, Kadoma-shi, Osaka 571-8686, Japan, Tel. (06) 6908-1050, Fax (06) 6908-5781, www.mew.co.jp/e-acg/
▶ Singapore	Panasonic Electric Works Asia Pacific Pte. Ltd.	101 Thompson Road, #25-03/05, United Square, Singapore 307591, Tel. (06255) 5473, Fax (06253) 5689