



■ Features

- Constant voltage and current output
- Universal AC input 100~305VAC
- Built-in active PFC function
- High efficiency
- Output protections: Short circuit/Over voltage/Over load
- Fixed derating-cutoff type temperature protection
- Cooling by free air convection
- Digital, analog or remote control dimming function
- Suitable for LED lighting and LED Electronic display applications
- IP65 with Vo/Io adjusting screws, IP67 without Vo/Io adjusting screws
- Compliance to worldwide safety regulations for lighting
- Suitable for dry / damp / wet locations



IP65/67



■ General functions

Output Power	60W	Input Frequency	50/60Hz
Input Voltage Range	100~305Vac	Operating Temperature	-40°C ~ +60°C
Storage Temperature	-45°C ~ +85°C	Safety & EMC	UL8750, IEC61347, EN55015
Turn-on Delay Time	3.0S max.	Inrush Current	65A
Over Temp Protection	Fixed derating-cutoff type temperature protection	Waterproof	IP65/IP67

■ Detailed Specification

TABLE 1:

Model		DR060-172S035	DR060-086S070	DR060-057S105	DR060-048S130	DR060-042S140	DR060-036S175	DR060-030S210	DR060-024S250	DR060-020S300	
Output	DC Voltage	172Vdc	86Vdc	57Vdc	48Vdc	42Vdc	36Vdc	30Vdc	24Vdc	20Vdc	
	Constant Current Range	104~172Vdc	52~86Vdc	34~57Vdc	29~48Vdc	26~42Vdc	22~36Vdc	18~30Vdc	14.4~24Vdc	12~20Vdc	
	Rated DC Current	350mA	700mA	1050mA	1300mA	1400mA	1750mA	2100mA	2500mA	3000mA	
	Dimming Current Range	10~100%rated output current (≥50% rated output voltage)									
	Ripple and Noise	10%Vo	10%Vo	10%Vo	10%Vo	10%Vo	10%Vo	10%Vo	10%Vo	10%Vo	10%Vo
	Voltage ADJ. Range note.3	155~181Vdc	77~91Vdc	51~60Vdc	43~50Vdc	38~44Vdc	32~38Vdc	27~32Vdc	22~25Vdc	18~21Vdc	
	Current ADJ. Range note.3	210~350mA	420~700mA	630~1050mA	780~1300mA	840~1400mA	1050~1750mA	1260~2100mA	1500~2500mA	1800~3000mA	
	Voltage Tolerance	±5%	±5%	±5%	±5%	±5%	±5%	±5%	±5%	10%	10%
	Voltage Line Regulation	±3%	±3%	±3%	±3%	±3%	±3%	±3%	±3%	±3%	±3%
	Voltage Load Regulation	±5%	±5%	±5%	±5%	±5%	±5%	±5%	±5%	±5%	±5%
Input	Efficiency	91%	91%	91.0%	91.0%	90.0%	90.0%	90.0%	89%	88.0%	
	Power Factor	0.96/220Vac	0.96/220Vac	0.96/220Vac	0.96/220Vac	0.96/220Vac	0.96/220Vac	0.96/220Vac	0.96/220Vac	0.96/220Vac	
	AC Current	0.8A/100VAC,0.36A/220VAC									
	Leakage Current	<0.75mA/230VAC;<0.5mA/120VAC									
Output Protection	Over Current	Constant current limiting									
	Short Circuit	Non-dimmer type: recover automatically at hiccup;Dimmer type: Short-circuit power ≤10W.									
	Over Voltage	Shut down at 140%Vo and latch off o/p voltage, re-power on to recover									
Environmental	Operating Humidity	20~95%RH,non-condensing									
	Storage Humidity	10~95%RH									
	Temperature Coefficient	±0.03%/°C (0~50°C)									
	Vibration	10~300HZ,1G ,Period for 60min,each along X、Y、Z axes.									
Safety & EMC	Withstand Voltage	I/P-OP:3.75KVAC; IP-FG:1.56KAC/2.00KVAC(remove discharge tube); O/P-FG:2.00KVAC									
	Isolation Resistance	IP-OP,IP-FG,O/P-FG:100MOhms/500VDC/25°C/70%RH									
	EMC Interference	Compliance to EN55015, EN55022 (CISPR22) Class B									
	EMC Emission	Compliance to EN61000-3-2 Class C (≥50%load) ;EN61000-3-3									
	EMC Immunity	Compliance to EN61000-4-2,3,4,5,6,8,11;ENV50204, EN61547, EN55024,									
Others	Authentication	UL/CE									
	MTBF	377kHrsat full load and 30°Cambient conditions per MIL-HDBK-217F									
	Input Over-voltage	Can survive input over-voltage stress of 320Vac for 48 hours.									
	Dimensions (mm)	199×59×40									
	Max. Case Temp.	Tc max=80°C									
	Net Weight	0.825Kg/pcs									
Note	1. All parameters NOT specially mentioned are measured at 230VAC input, rated load and 25 of ambient temperature.										
	2. Ripple & noise are measured: at 20MHz of bandwidth by using a 12" twisted pair-wire terminated with a 0.1uf & 47uf parallel capacitor.										
	3.Output voltage and current can be adjusted by internal potentiometer ("A" type only)										
	4.Tolerance: includes set up tolerance, voltage line regulation and voltage load regulation.										
	5. Constant current operation region is within 60% ~100% rated output voltage. This is the suitable operation region for LED related applications, but please reconfirm special electrical requirements for some specific system design.										
	6. Derating may be needed under low input voltages. Please check the Static Characteristics for more details.										
	7. Safety and EMC design refer to EN60598-1, subject8750(UL),CNS15233, GB7000.1, FCC part18.										
	8. Length of set up time is measured at cold first start. Turning ON/OFF the power supply may lead to increase of the set up time.										
	9. The power supply is considered as a component that will be operated in combination with final equipment. Since EMC performance will be affected by the complete installation, the final equipment manufacturers must re-qualify EMC Directive on the complete installation again.										

TABLE 2:

Model		DR060-016S375	DR060-012S500							
Output	DC Voltage	16Vdc	12Vdc							
	Constant Current Range	10~16Vdc	7.2~12Vdc							
	Rated DC Current	3750mA	5000mA							
	Dimming Current Range	10~100%rated output current (≥50% rated output voltage)								
	Ripple and Noise	10%Vo	10%Vo							
	Voltage ADJ. Range <small>note.3</small>	14~17Vdc	11~13Vdc							
	Current ADJ. Range <small>note.3</small>	2250~3750mA	3000~5000mA							
	Voltage Tolerance	±10%	±10%							
	Voltage Line Regulation	±3%	±3%							
	Voltage Load Regulation	±5%	±5%							
Input	Efficiency	87.0%	86%							
	Power Factor	0.96/220Vac	0.96/220Vac							
	AC Current	0.8A/100VAC,0.36A/220VAC								
	Leakage Current	<0.75mA/230VAC;<0.5mA/120VAC								
Protection	Over Current	Constant current limiting								
	Short Circuit	Non-dimmer type: recover automatically at hiccup ;Dimmer type: Short-circuit power ≤10W.								
	Over Voltage	Shut down at 140%Vo and latch off o/p voltage, re-power on to recover								
Environmental	Operating Humidity	20~95%RH,non-condensing								
	Storage Humidity	10~95%RH								
	Temperature Coefficient	±0.03%/°C (0~50°C)								
	Vibration	10~300HZ,1G ,Period for 60min,each along X、 Y、 Z axes.								
Safety&EMC	Withstand Voltage	I/P-OP:3.75KVAC; IP-FG:1.56KAC/2.00KVAC(remove discharge tube); O/P-FG:2.00KVAC								
	Isolation Resistance	IP-OP,IP-FG,O/P-FG:100MOhms/500VDC/25°C/70%RH								
	EMC Interference	Compliance to EN55015, EN55022 (CISPR22) Class B								
	EMC Emission	Compliance to EN61000-3-2 Class C (≥50%load) ;EN61000-3-3								
	EMC Immunity	Compliance to EN61000-4-2,3,4,5,6,8,11;ENV50204, EN61547, EN55024,								
Others	Authentication	UL/CE								
	MTBF	377kHrsat full load and 30°C ambient conditions per MIL-HDBK-217F								
	Input Over-voltage	Can survive input over-voltage stress of 320Vac for 48 hours.								
	Dimensions (mm)	199×59×40								
	Max. Case Temp.	Tc max=80°C								
	Net Weight	0.825Kg/pcs								
Note	1. All parameters NOT specially mentioned are measured at 230VAC input, rated load and 25 of ambient temperature.									
	2. Ripple & noise are measured: at 20MHz of bandwidth by using a 12" twisted pair-wire terminated with a 0.1uf & 47uf parallel capacitor.									
	3.Output voltage and current can be adjusted by internal potentiometer ("A" type only)									
	4.Tolerance : includes set up tolerance, voltage line regulation and voltage load regulation.									
	5. Constant current operation region is within 60% ~100% rated output voltage. This is the suitable operation region for LED related applications, but please reconfirm special electrical requirements for some specific system design.									
	6. Derating may be needed under low input voltages. Please check the Static Characteristics for more details.									
	7. Safety and EMC design refer to EN60598-1, subject8750(UL),CNS15233, GB7000.1, FCC part18.									
	8. Length of set up time is measured at cold first start. Turning ON/OFF the power supply may lead to increase of the set up time.									
	9. The power supply is considered as a component that will be operated in combination with final equipment. Since EMC performance will be affected by the complete installation, the final equipment manufacturers must re-qualify EMC Directive on the complete installation again.									

Part number code

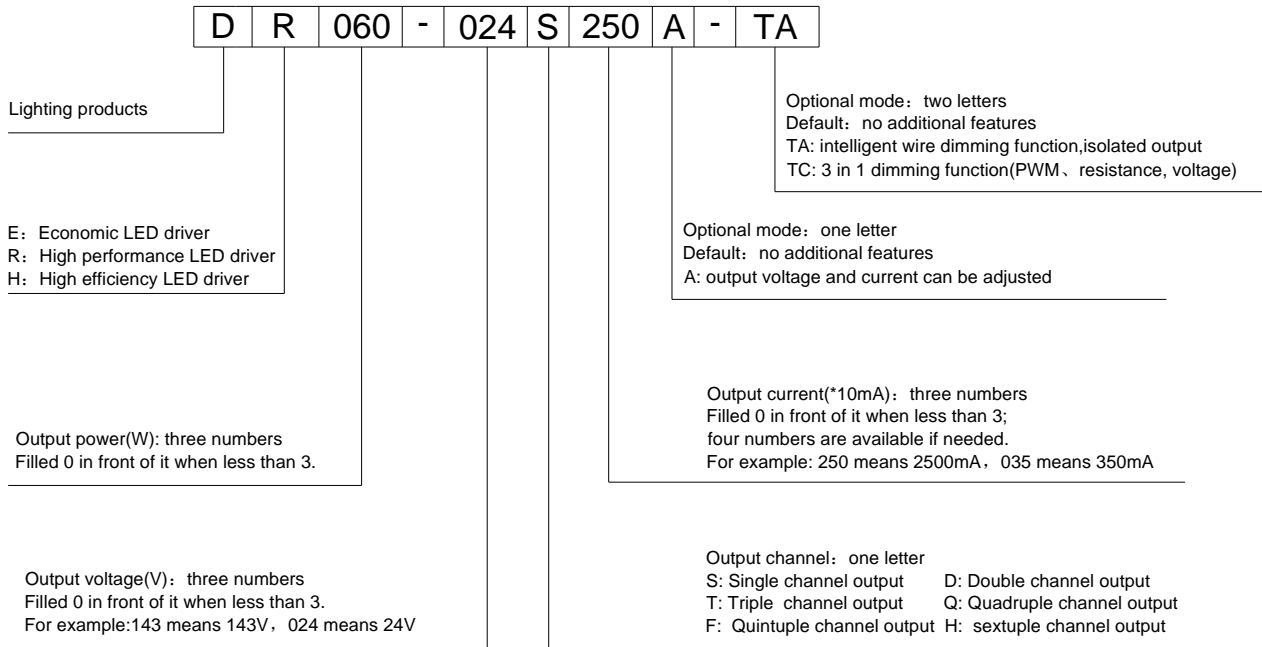

For example: DR060-024S250A-TA means: high performance LED driver; output power 60W; output voltage 24Vdc; output current 2500mA; single output; output voltage and current can be adjusted; with intelligent wire dimming function and isolated output.

wiring diagram

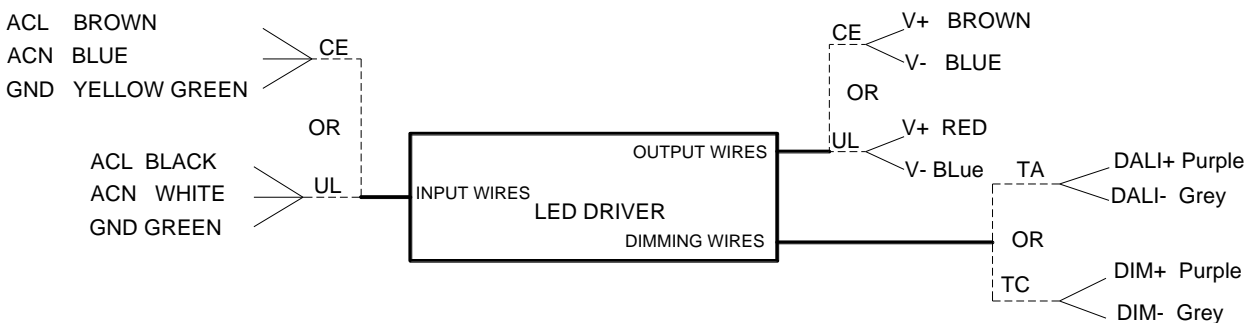

■ Derating Curve

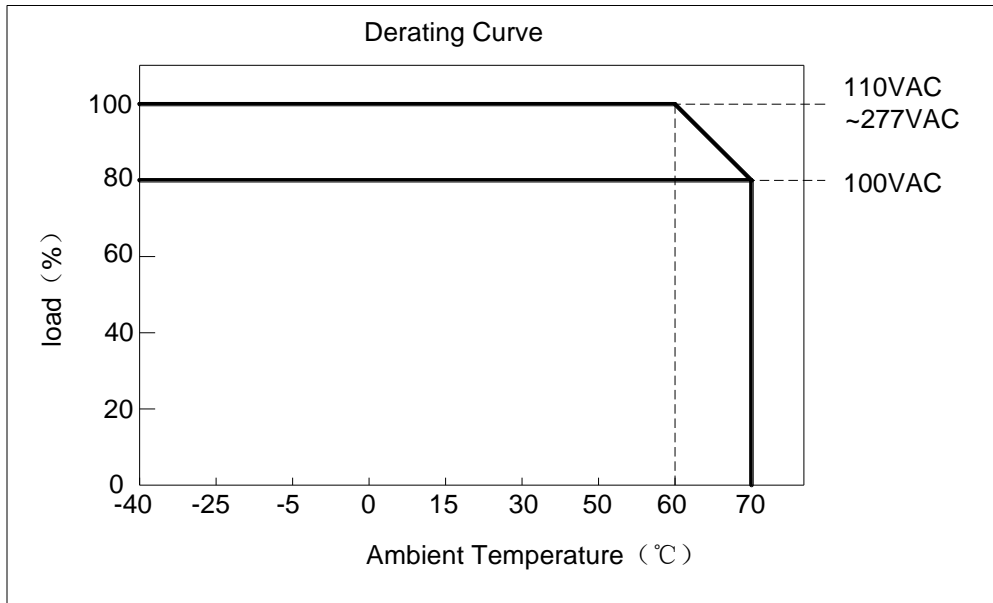

■ Static Characteristics

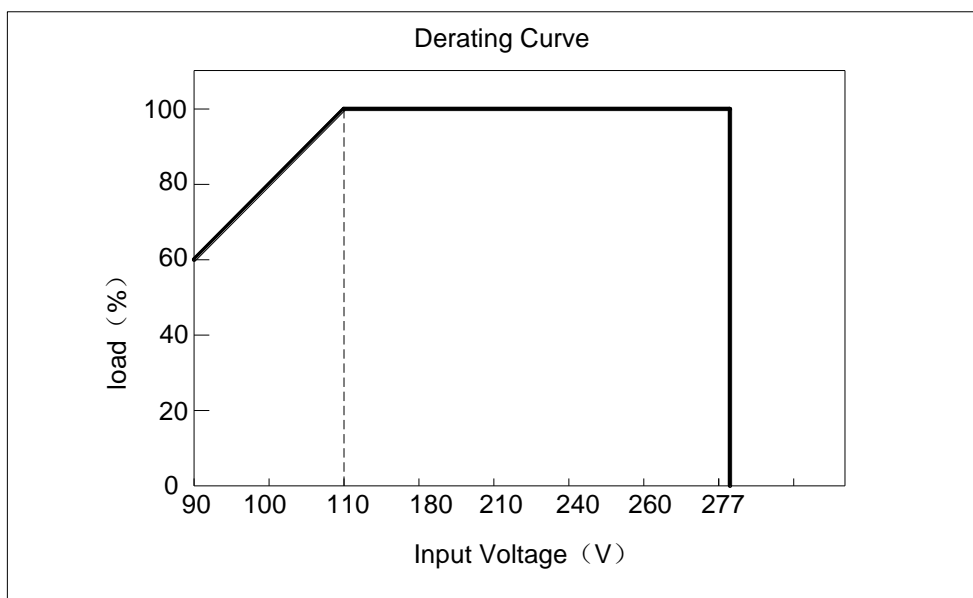

■ Power Factor Characteristic

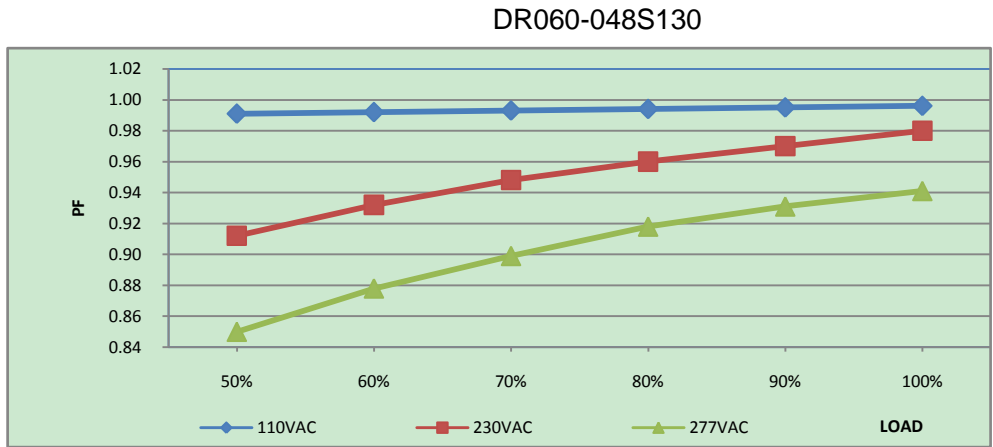

■ EFFICIENCY vs LOAD

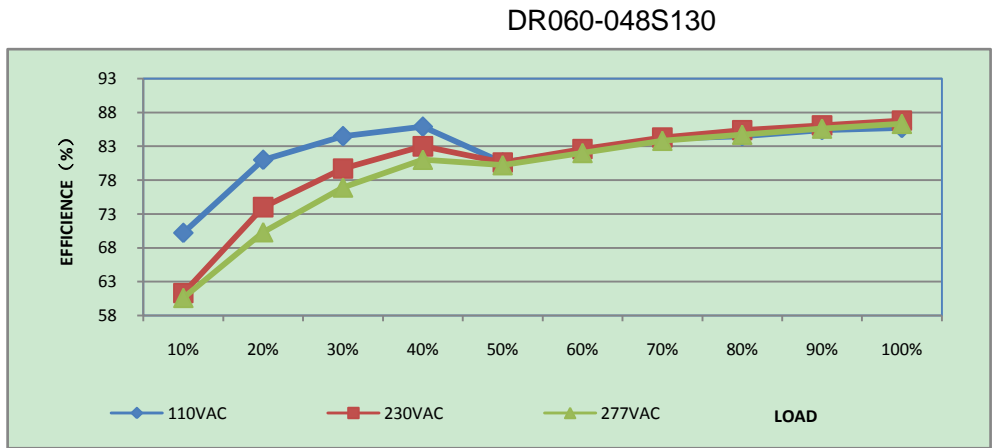

■ Typical LED power supply I-V curve

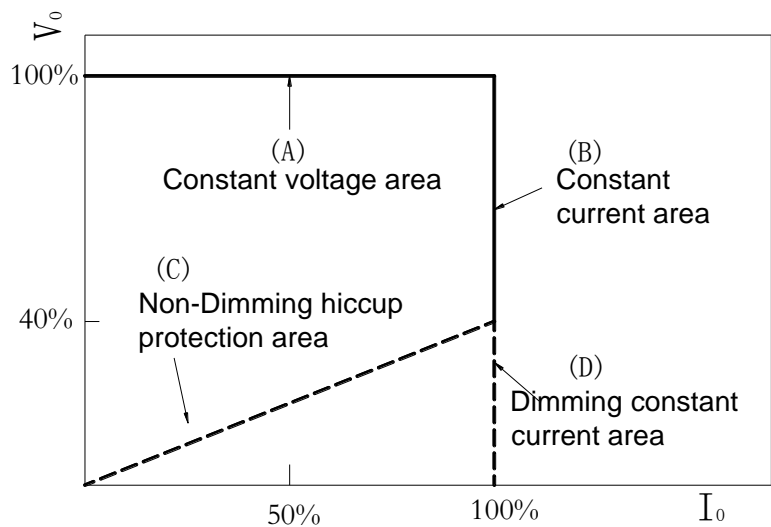

■ Mechanical Outline

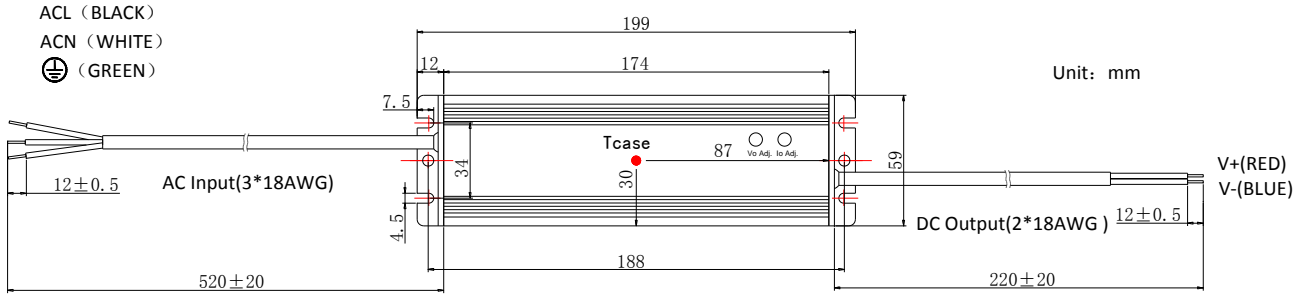

※Tcase: Max. Case Temperature

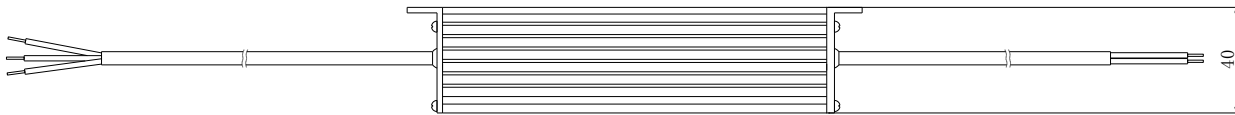

※Power's internal temperature is 10 °C warmer than case temperature.

■ Isolated intelligent dimming and control

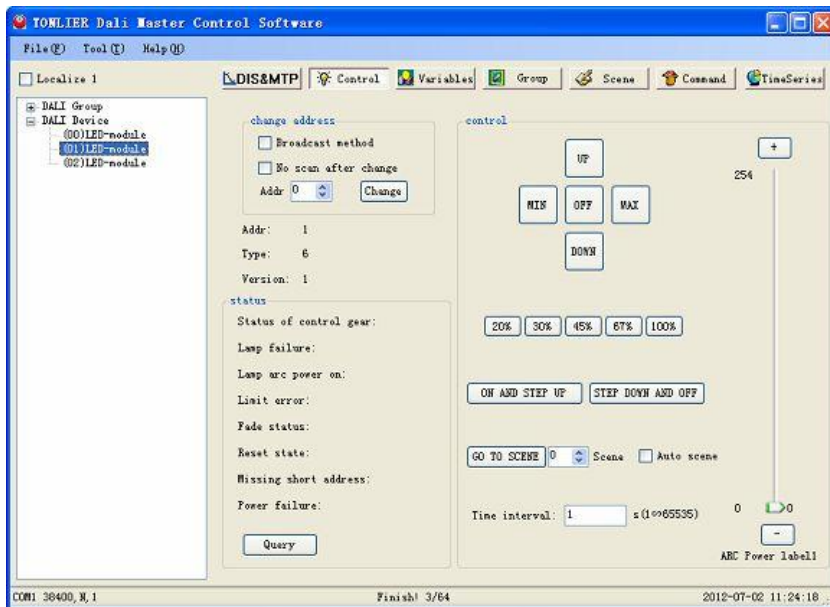

Programming Tool: Please refer to www.tonlier.com for downloading .

“TA” version led driver shall work with a DALI Master and a DALI Master control software.
An application example for DALI Master with RS232 bus connection:

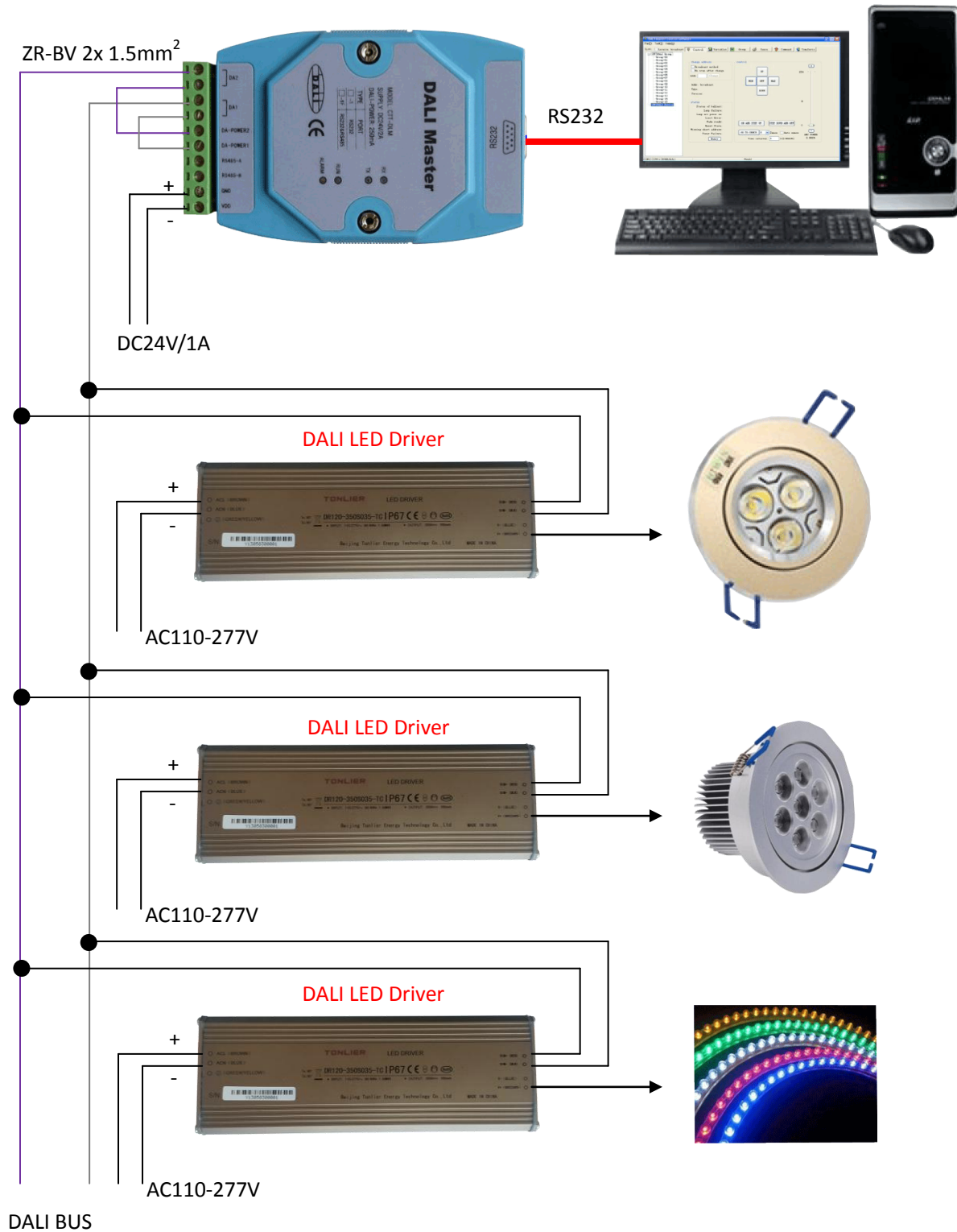

■ Non-isolated 3 in 1 dimming function

Reference resistance value for output current adjustment (Typical)

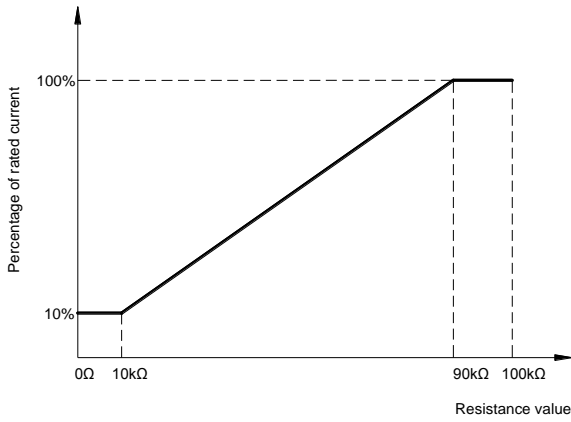

1 ~ 10V dimming function for output current adjustment (Typical)

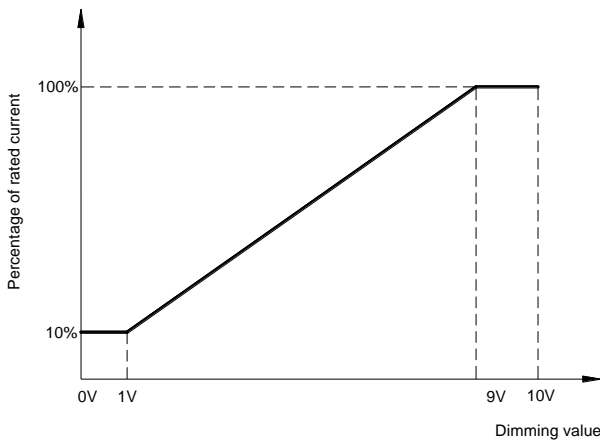

10V PWM signal for output current adjustment (Typical): Frequency range:100HZ ~ 3KHZ

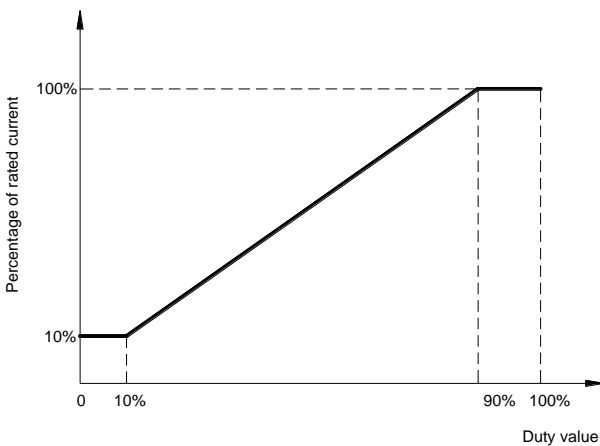

Dimming control details:

Parameters		Minimum	Typical	Maximum
Dimming Type	Resistance	0kΩ	10-100kΩ	∞
	Voltage	-2V	1-10V	15V
	PWM(10%~100% f=200~500Hz)	-2V	0-10V	15V
Dimming Current		-0.5mA	-	0.5mA

■ **Input and output Dielectric strength**

Isolation	Input Wires	Output Wires	Isolated Dimming Control Wires	Chassis
Input Wires	NA	3750	2000	1560/2000 (remove discharge tube)
Output Wires	3750	NA	2000	2000
Isolated Dimming Control Wires	2000	2000	NA	2000
Chassis	1560/2000 (remove discharge tube)	2000	2000	NA

■ **Fixed derating-cutoff type temperature protection**

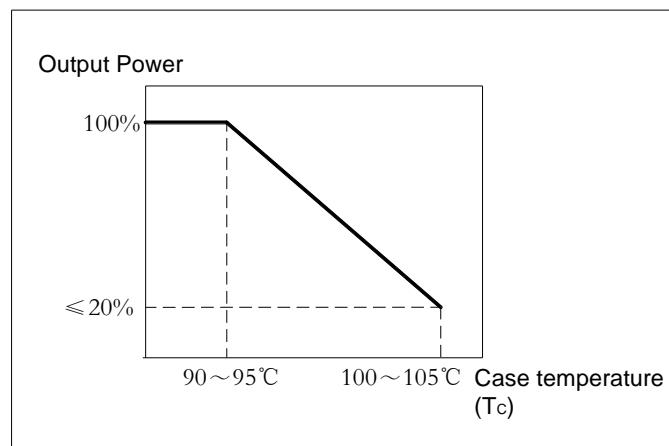

■ **Lifetime vs Case Temperature**

