

# Specification

**Acrich2 – Bulb**

**220V 13W**

**SMJE-3V12W1P3**

SSC		Customer
Drawn	Approval	Approval

## Acrich2 - 220V 13W Bulb

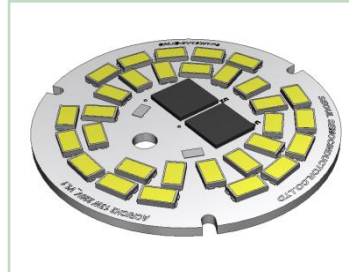

### Description

The Acrich 2 series, which are designed for AC drive(or operation), do not need the standard converter essential for a conventional general lighting product.

The modules also have a high power factor which can contribute to high energy savings in many lighting applications.

Since there is no need for a converter, the Acrich 2 series life-time can be estimated

closer to the LED because it is not as dependent on the other electronics in the system.

It also allows for better utilization of space without the converter.

## Acrich2

### Features

- Connect using a AIC directly to AC power
- High Power Efficiency
- High Power Factor
- Low THD
- Long Life Time
- Simplest BOM
- Miniaturization
- Lead Free product
- RoHS compliant

### Applications

- Bulb light
- Down light
- Factory Ceiling light
- Industrial Light

## [ Contents ]

<b>1. Characteristics</b>	<b>-----4</b>
<b>2. Thermal Resistance</b>	<b>-----7</b>
<b>3. Color spectrum</b>	<b>-----8</b>
<b>4. Power characteristics</b>	<b>-----10</b>
<b>5. Radiation pattern</b>	<b>-----11</b>
<b>6. Color &amp; Binning</b>	<b>-----12</b>
<b>7. Marking</b>	<b>-----15</b>
<b>8. Outline dimensions</b>	<b>-----15</b>
<b>9. Circuit Drawing</b>	<b>-----16</b>
<b>10. Packing</b>	<b>-----17</b>
<b>11. Usage precautions</b>	<b>-----18</b>
<b>12. Handling of silicone resin for LEDs</b>	<b>-----18</b>
<b>13. Handling with regards to static electricity</b>	<b>--19</b>
<b>14. Storage before use</b>	<b>-----19</b>

## 1. Characteristics

### 1-1-1. Electro-Optical characteristics of SMJE-3V12W1P3-B rank

Parameter	Symbol	Value			Unit
		Min	Typ	Max	
<b>Luminous Flux</b> [2]	$\Phi_v$ [3]	980	1030	-	lm
<b>Correlated Color Temperature</b> [4]	CCT	5300	5600	6000	K
<b>CRI</b>	$R_a$	80	-	-	-
<b>Operating Voltage</b> [5]	$V_{opt}$	220			V[RMS]
<b>Power Dissipation</b>	$P_D$	12.6	13.0	13.4	W
<b>Operating Frequency</b>	Freq	50 / 60			Hz
<b>Power Factor</b>	PF	Over 0.95			-
<b>View Angle</b>	$2\theta$ 1/2	120			deg.

### 1-1-2. Electro-Optical characteristics of SMJE-3V12W1P3-C rank

Parameter	Symbol	Value			Unit
		Min	Typ	Max	
<b>Luminous Flux</b> [2]	$\Phi_v$ [3]	980	1030	-	lm
<b>Correlated Color Temperature</b> [4]	CCT	4700	5000	5300	K
<b>CRI</b>	$R_a$	80	-	-	-
<b>Operating Voltage</b> [5]	$V_{opt}$	220			V[RMS]
<b>Power Dissipation</b>	$P_D$	12.6	13.0	13.4	W
<b>Operating Frequency</b>	Freq	50 / 60			Hz
<b>Power Factor</b>	PF	Over 0.95			-
<b>View Angle</b>	$2\theta$ 1/2	120			deg.

**1-1-3. Electro-Optical characteristics of SMJE-3V12W1P3-E rank**

Parameter	Symbol	Value			Unit
		Min	Typ	Max	
<b>Luminous Flux</b> [2]	$\Phi_V$ [3]	920	960	-	lm
<b>Correlated Color Temperature</b> [4]	CCT	3700	4000	4200	K
<b>CRI</b>	$R_a$	80	-	-	-
<b>Operating Voltage</b> [5]	$V_{opt}$	220			V[RMS]
<b>Power Dissipation</b>	$P_D$	12.6	13.0	13.4	W
<b>Operating Frequency</b>	Freq	50 / 60			Hz
<b>Power Factor</b>	PF	Over 0.95			-
<b>View Angle</b>	$2\theta$ 1/2	120			deg.

**1-1-4. Electro-Optical characteristics of SMJE-3V12W1P3-G rank**

Parameter	Symbol	Value			Unit
		Min	Typ	Max	
<b>Luminous Flux</b> [2]	$\Phi_V$ [3]	910	940	-	lm
<b>Correlated Color Temperature</b> [4]	CCT	2900	3000	3200	K
<b>CRI</b>	$R_a$	80	-	-	-
<b>Operating Voltage</b> [5]	$V_{opt}$	220			V[RMS]
<b>Power Dissipation</b>	$P_D$	12.6	13.0	13.4	W
<b>Operating Frequency</b>	Freq	50 / 60			Hz
<b>Power Factor</b>	PF	Over 0.95			-
<b>View Angle</b>	$2\theta$ 1/2	120			deg.

**1-1-5. Electro-Optical characteristics of SMJE-3V12W1P3-H rank**

Parameter	Symbol	Value			Unit
		Min	Typ	Max	
<b>Luminous Flux</b> [2]	$\Phi_V$ [3]	900	930	-	lm
<b>Correlated Color Temperature</b> [4]	CCT	2600	2700	2900	K
<b>CRI</b>	$R_a$	80	-	-	-
<b>Operating Voltage</b> [5]	$V_{opt}$	220			V[RMS]
<b>Power Dissipation</b>	$P_D$	12.6	13.0	13.4	W
<b>Operating Frequency</b>	Freq	50 / 60			Hz
<b>Power Factor</b>	PF	Over 0.95			-
<b>View Angle</b>	$2\theta$ 1/2	120			deg.

**1-2 Absolute Maximum Ratings**

Parameter	Symbol	Value	Unit
<b>Max. Voltage</b>	$V_{opt}$	264	V[RMS]
<b>Power Dissipation</b>	$P_d$	17.5	W
<b>Operating Temperature</b>	$T_{opr}$	-30 ~ 85	°C
<b>Storage Temperature</b>	$T_{stg}$	-40 ~ 100	°C
<b>ESD Sensitivity</b>	-	±4,000V HBM	-

\* Notes :

[1] At 220V RMS,  $T_a=25^\circ\text{C}$

[2] Acrich 2 series maintain the tolerance of  $\pm 10\%$  on flux and power measurements.

[3]  $\Phi_V$  is the total luminous flux output measured with an integrated sphere.

[4] Correlated Color Temperature is derived from the CIE 1931 Chromaticity diagram.

[5] Operating Voltage doesn't indicate the maximum voltage which customers use but means tolerable voltage according to each country's voltage variation rate.

It is recommended that the solder pad temperature should be below  $70^\circ\text{C}$ .

## 2. Thermal Resistance

Part	Package Power Dissipation [W]	Maximum Junction Temp[ °C]	R $\theta_{j-s}$ [°C/W]
Acrich2 LED	SAW8KG0B Max 0.5	125	27
Acrich2 IC	Max 1.5	125	5.5

The Acrich2 LED has a thermal resistance of 27degC/W from junction to the LED lead.

The maximum junction temperature of Acrich2 LED package is 125degC, therefore the maximum lead temperature T<sub>s\_max</sub> is

$$T_{s\_max} = T_{j\_max} - (R\theta_{j-s} * P_D)$$

$$= 125^{\circ}\text{C} - (27^{\circ}\text{C}/\text{W} * 0.5\text{W}) = 111.5^{\circ}\text{C}$$

Although this is the maximum lead temperature, it is recommended to keep the lead temperature under 70degC

The Acrich2 IC has a 5.5degC/W thermal resistance from junction to the top surface.

The maximum junction temperature (T<sub>t\_max</sub>) of the IC is 125degC, therefore the maximum temperature of the top of the IC is

$$T_{t\_max} = T_{j\_max} - (\psi_{j-t} * P_D)$$

$$= 125^{\circ}\text{C} - (5.5^{\circ}\text{C}/\text{W} * 1.5\text{W}) = 116.8^{\circ}\text{C}$$

### 3. Color spectrum

Warm-White Relative Spectral Power Distribution at Ta=25 °C

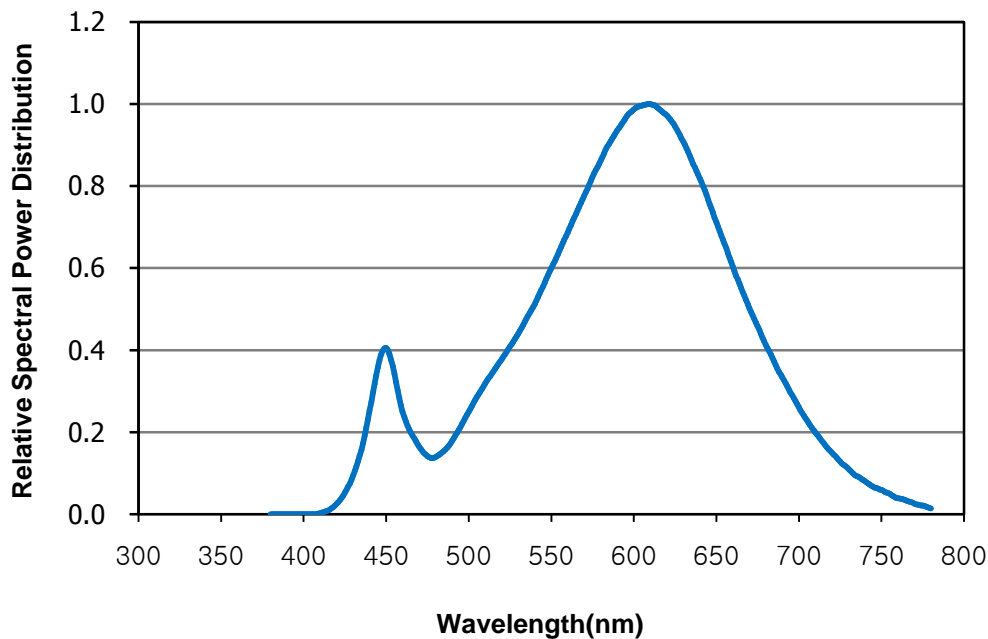

Neutral-White Relative Spectral Power Distribution at Ta=25 °C

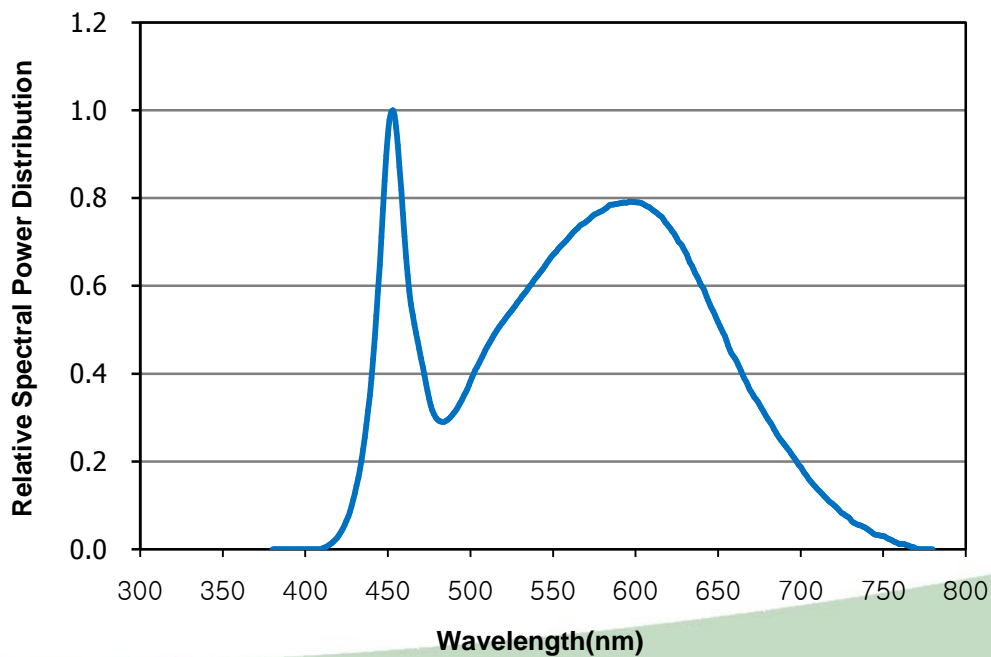



**Cool-White Relative Spectral Power Distribution at Ta=25 °C**

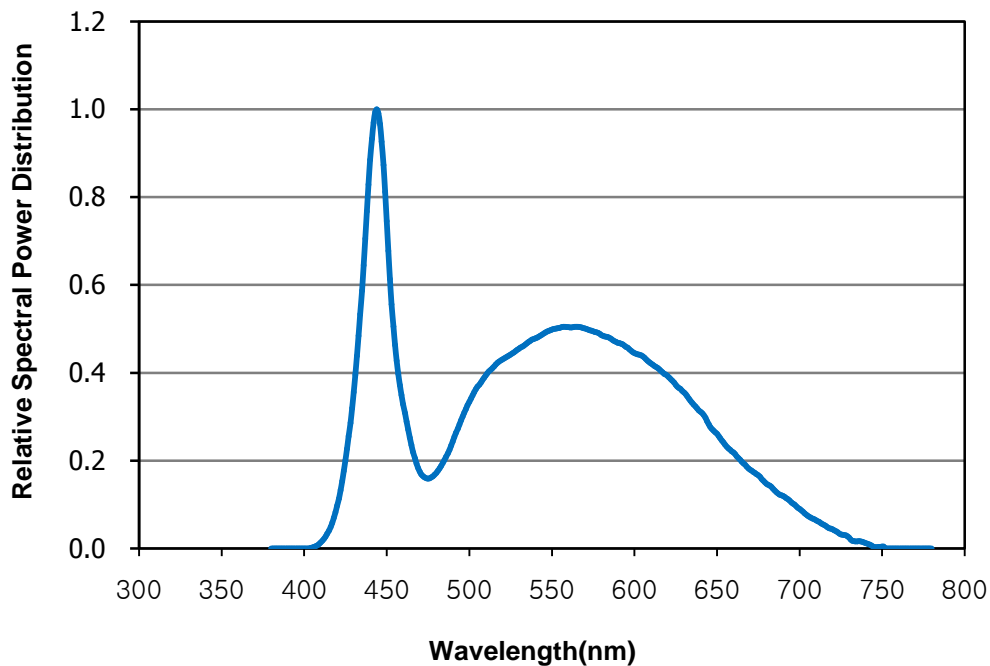

## 4. Power characteristic

Relative Power Distribution vs. Voltage at Ta=25 °C

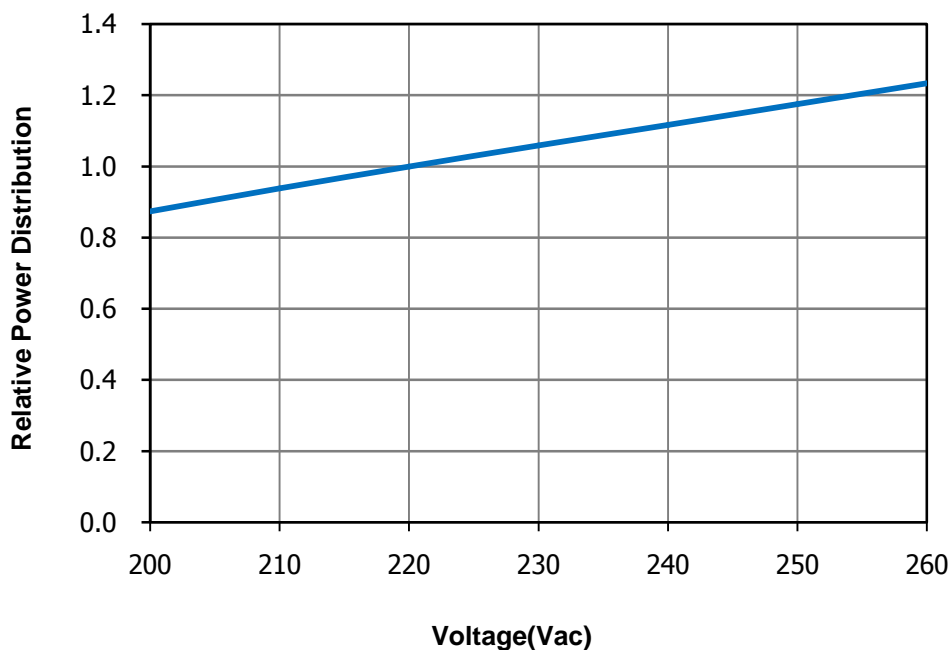

Relative Luminous Flux vs. Voltage at Ta=25 °C

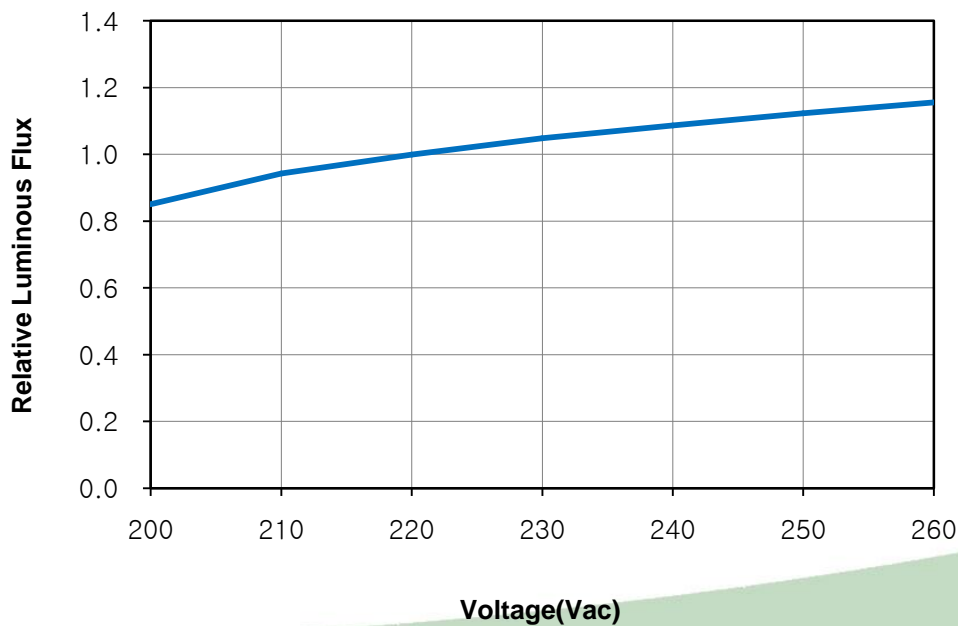

## 5. Radiation Pattern

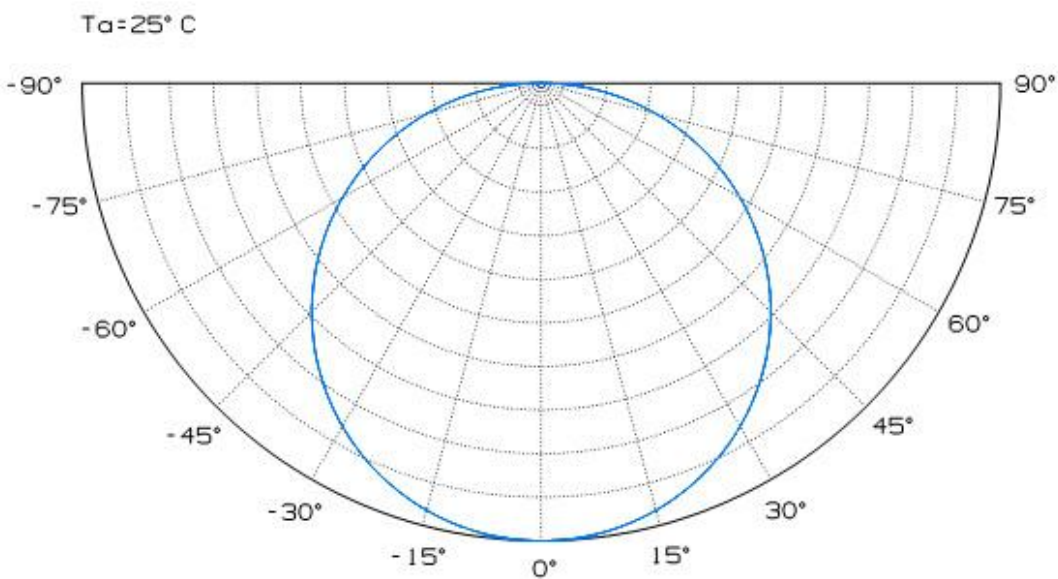

## 6. Color & Binning

### 6-1. Warm White Ansi binning structure range 2,600K(H) to 3,200K(G)

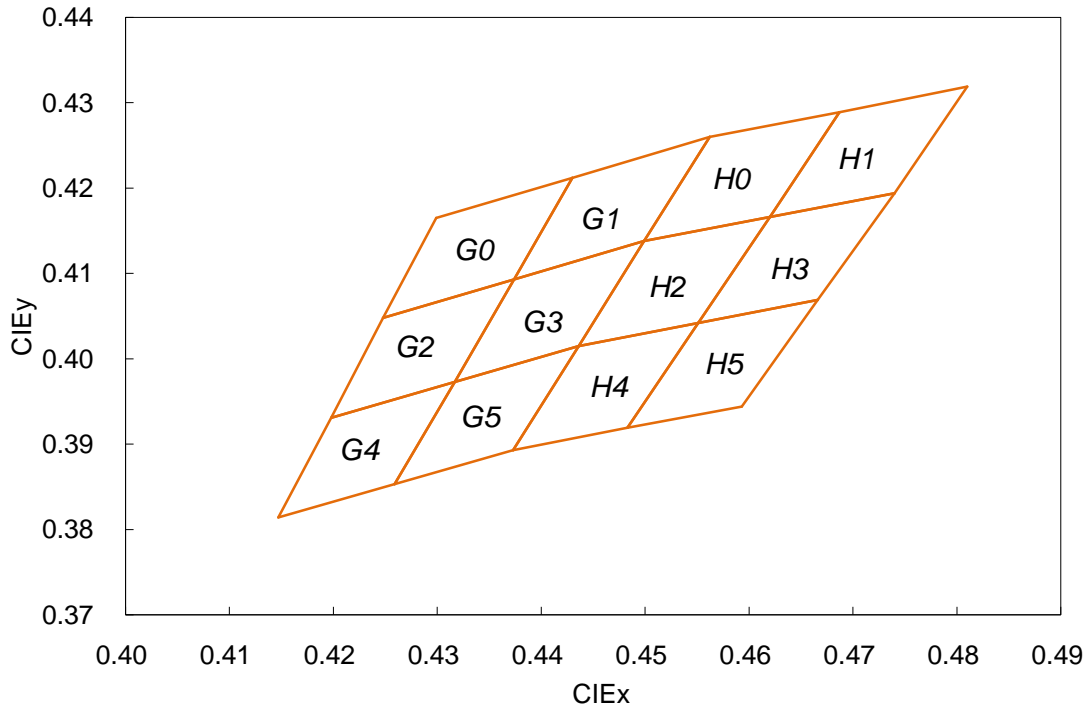

Bin code	X	Y	Bin code	X	Y	Bin code	X	Y
G0	0.4299	0.4165	G1	0.4430	0.4212	G2	0.4248	0.4048
	0.4248	0.4048		0.4374	0.4093		0.4198	0.3931
	0.4374	0.4093		0.4499	0.4138		0.4317	0.3973
	0.4430	0.4212		0.4562	0.4260		0.4374	0.4093
G3	0.4374	0.4093	G4	0.4198	0.3931	G5	0.4317	0.3973
	0.4317	0.3973		0.4147	0.3814		0.4259	0.3853
	0.4436	0.4015		0.4259	0.3853		0.4373	0.3893
	0.4499	0.4138		0.4317	0.3973		0.4436	0.4015
H0	0.4562	0.4260	H1	0.4687	0.4289	H2	0.4499	0.4138
	0.4499	0.4138		0.4620	0.4166		0.4436	0.4015
	0.4620	0.4166		0.4740	0.4194		0.4551	0.4042
	0.4687	0.4289		0.4810	0.4319		0.4620	0.4166
H3	0.4620	0.4166	H4	0.4436	0.4015	H5	0.4551	0.4042
	0.4551	0.4042		0.4373	0.3893		0.4483	0.3919
	0.4666	0.4069		0.4483	0.3919		0.4593	0.3944
	0.4740	0.4194		0.4551	0.4042		0.4666	0.4069

**6-1. Neutral White Ansi binning structure range 3,700K to 4,200K**

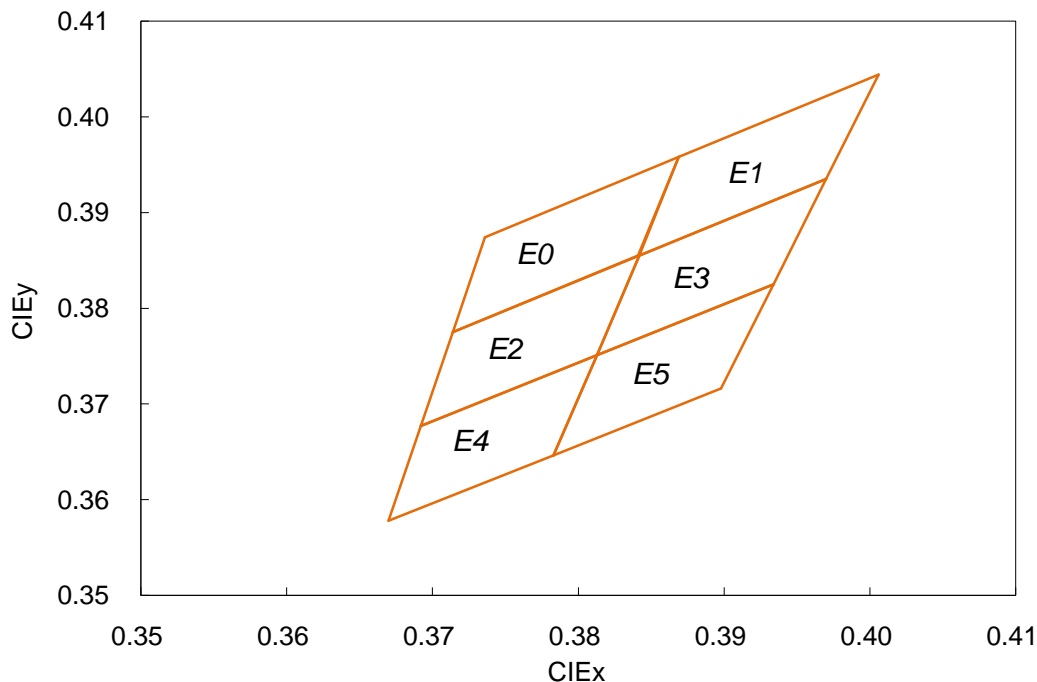

Bin code	X	Y	Bin code	X	Y	Bin code	X	Y
E0	0.3736	0.3874	E1	0.3869	0.3958	E2	0.3714	0.3775
	0.3714	0.3775		0.3842	0.3855		0.3692	0.3677
	0.3841	0.3855		0.3970	0.3935		0.3813	0.3751
	0.3869	0.3958		0.4006	0.4044		0.3842	0.3855
E3	0.3842	0.3855	E4	0.3692	0.3677	E5	0.3813	0.3751
	0.3813	0.3751		0.3670	0.3578		0.3783	0.3646
	0.3934	0.3825		0.3783	0.3646		0.3898	0.3716
	0.3970	0.3935		0.3813	0.3751		0.3934	0.3825

**6-1. Cool White Ansi binning structure range 4,700K to 6,000K**

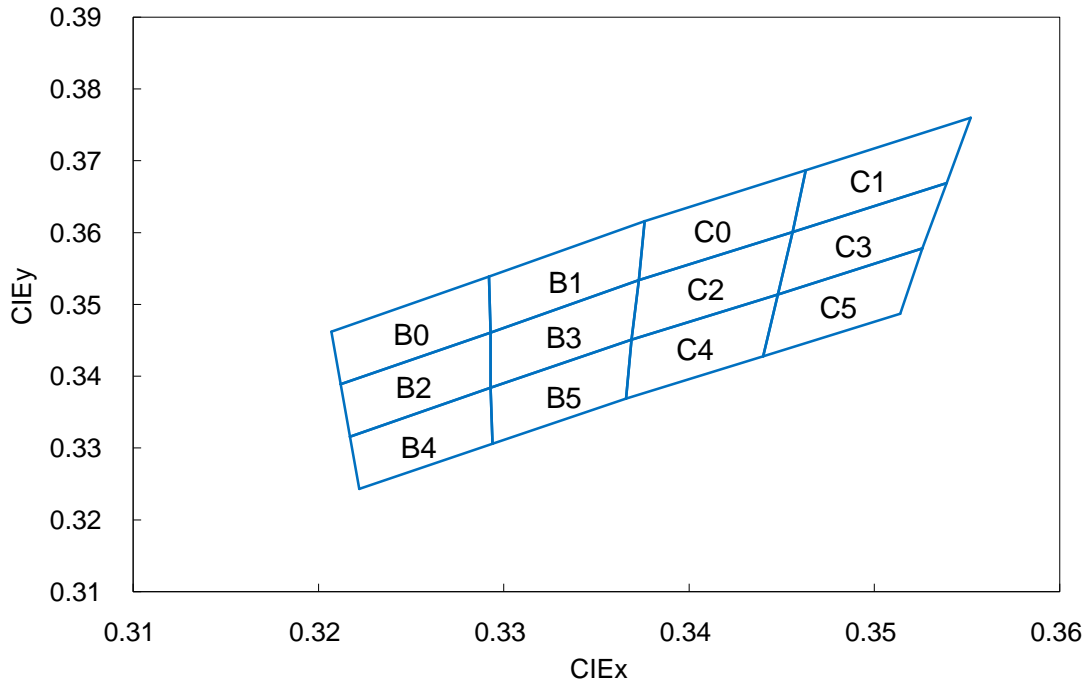

Bin code	X	Y	Bin code	X	Y	Bin code	X	Y
B0	0.3207	0.3462	B1	0.3292	0.3539	B2	0.3212	0.3389
	0.3212	0.3389		0.3293	0.3461		0.3217	0.3316
	0.3293	0.3461		0.3373	0.3534		0.3293	0.3384
	0.3292	0.3539		0.3376	0.3616		0.3293	0.3461
B3	0.3293	0.3461	B4	0.3217	0.3316	B5	0.3293	0.3384
	0.3293	0.3384		0.3222	0.3243		0.3294	0.3306
	0.3369	0.3451		0.3294	0.3306		0.3366	0.3369
	0.3373	0.3534		0.3293	0.3384		0.3369	0.3451
C0	0.3376	0.3616	C1	0.3463	0.3687	C2	0.3373	0.3534
	0.3373	0.3534		0.3456	0.3601		0.3369	0.3451
	0.3456	0.3601		0.3539	0.3669		0.3448	0.3514
	0.3463	0.3687		0.3552	0.3760		0.3456	0.3601
C3	0.3456	0.3601	C4	0.3369	0.3451	C5	0.3448	0.3514
	0.3448	0.3514		0.3366	0.3369		0.3440	0.3428
	0.3526	0.3578		0.3440	0.3428		0.3514	0.3487
	0.3539	0.3669		0.3448	0.3514		0.3526	0.3578

## 7. Marking

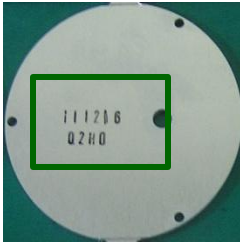

XXXXXX – Year / Month/date / Production date  
 XXXX – LED PKG Flux Rank / Color Bin Rank

## 8. Outline dimensions

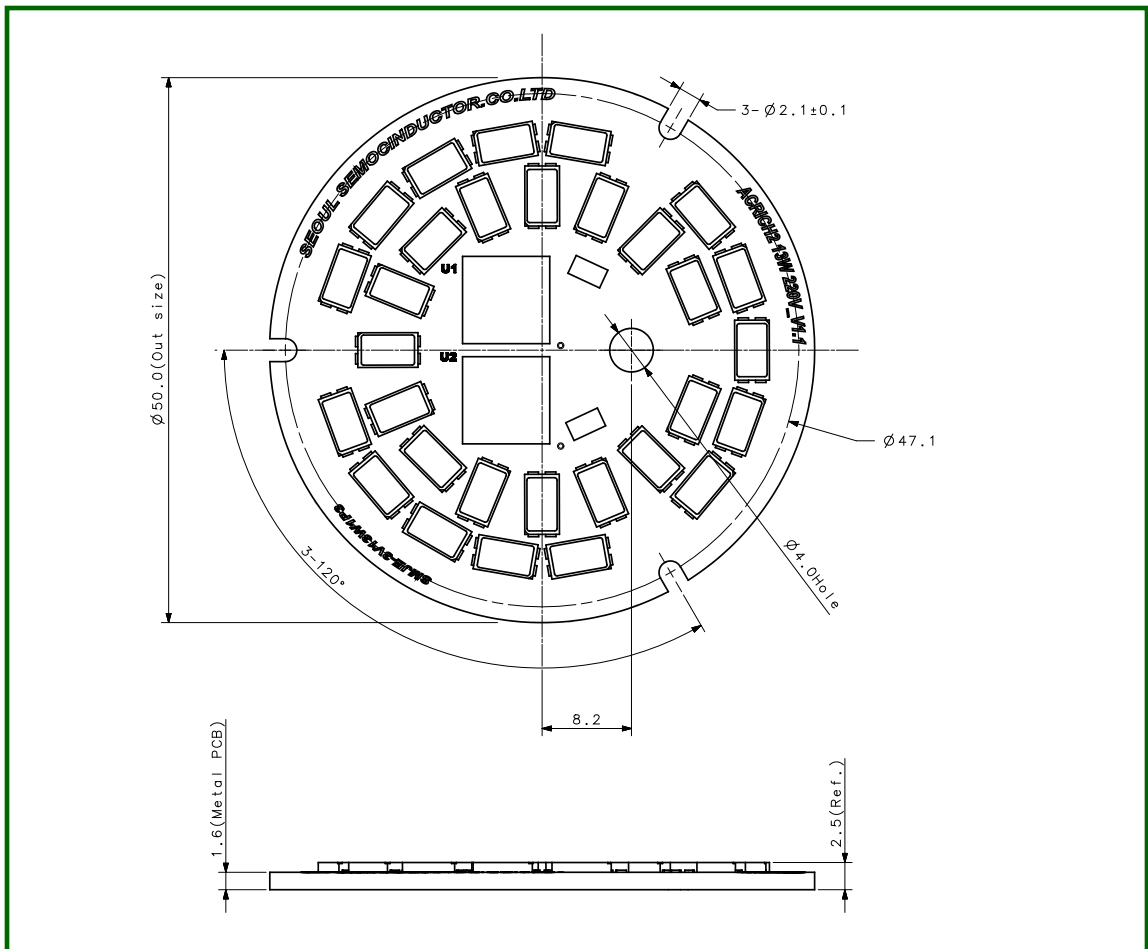

\* Notes :

- [1] All dimensions are in millimeters. (Tolerance :  $\pm 0.2$ )
- [2] Scale : none

## 9. Circuit Drawing

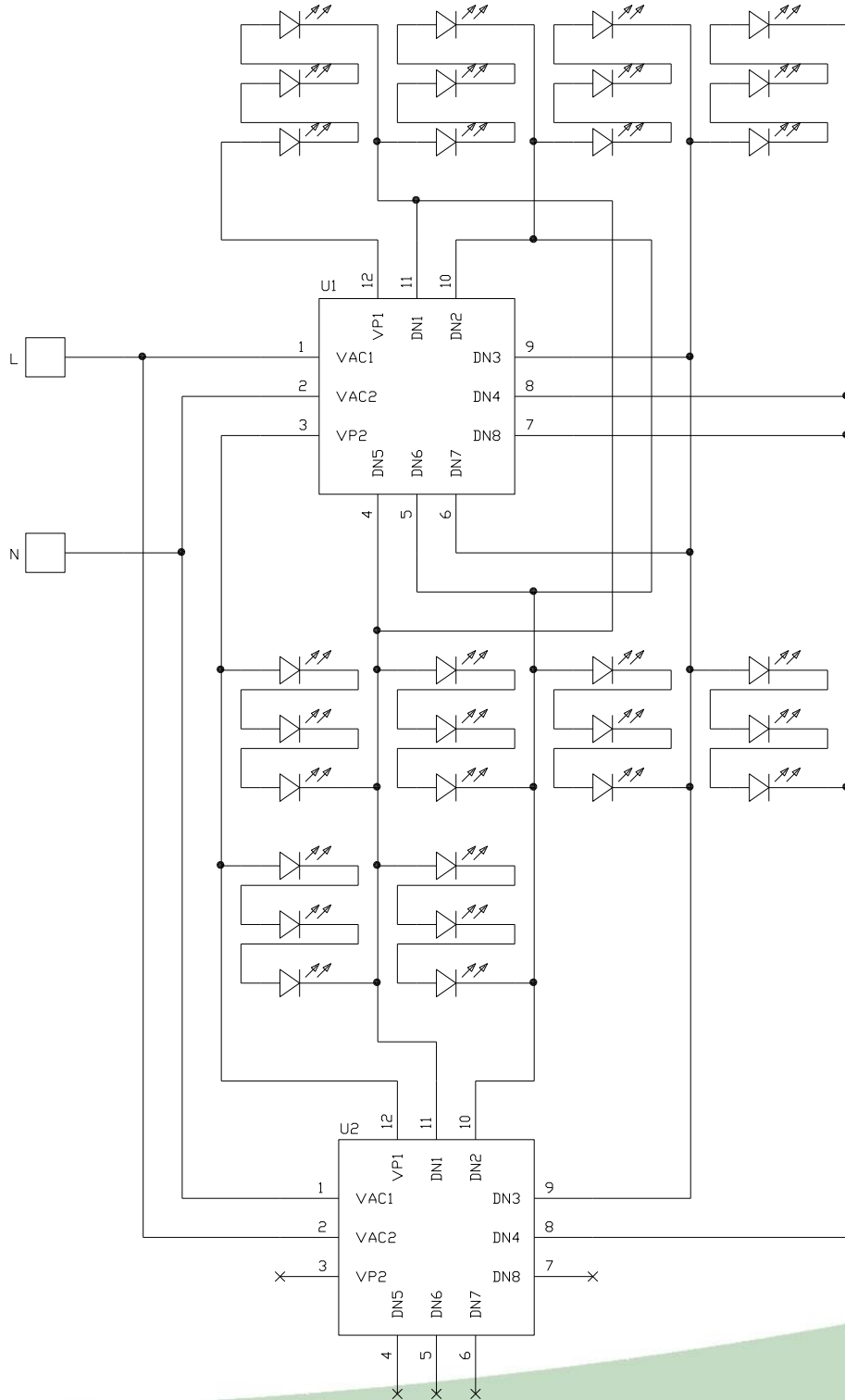



## 10. Packing

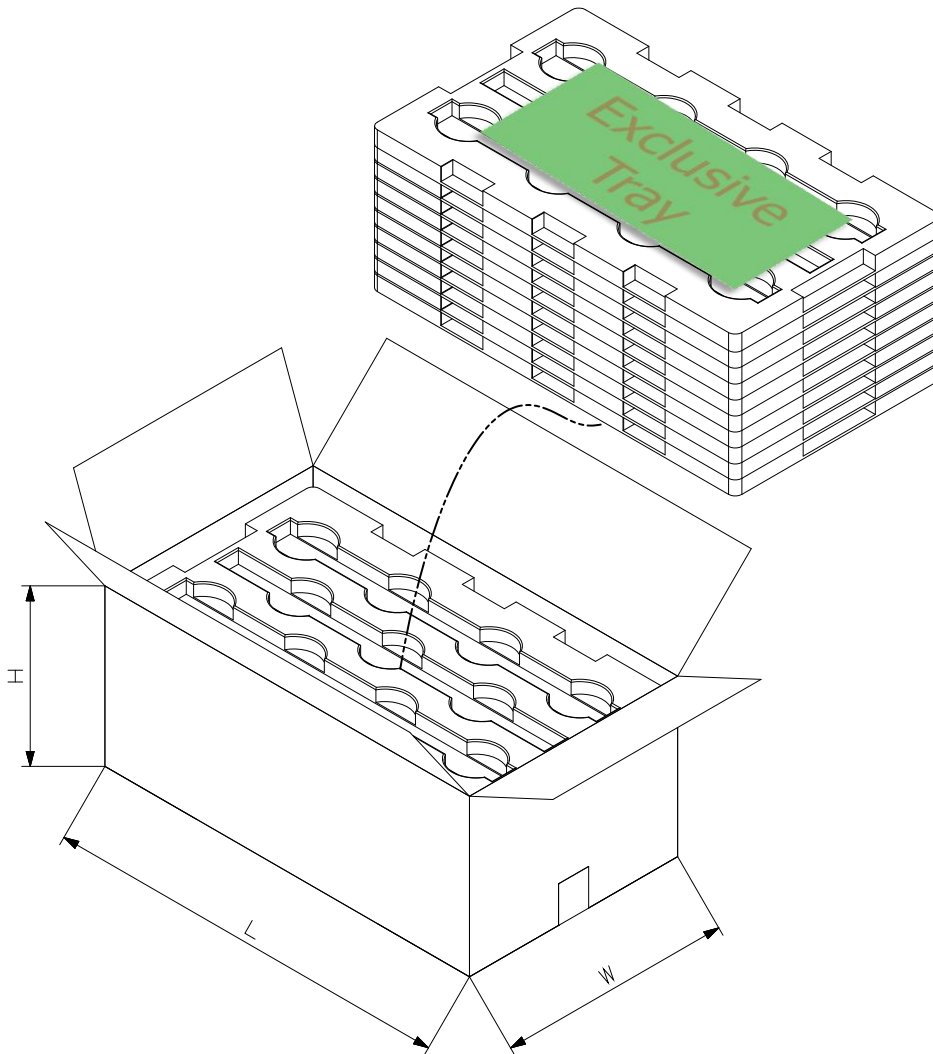

◦ **1Box : 50 PCS per tray x Max 8 layer = Max 400 PCS**

**about 6kg**

◦ **Box size( L x W x H ) = 590 x 330 x 260**

## 11. Usage precautions

- Please review the Acrich2 Module Application Note for protective circuitry component usage.
- Please note, the Acrich products run on high voltage so use caution when near the the device which the circuit is active.
- DO NOT touch any of the circuit board, components or terminals with body or metal while circuit is active.
- Please do not add or change wires while Acrich circuit is active
- Long time exposure of sunlight or occasional UV exposure will cause lens discoloration.
- Please do not use adhesives to attach the LED that outgas organic vapor.
- Please do not use together with the materials containing Sulfur
- Please do not assemble under the condition of moisture and oxidizing gas in the air(Cl, H<sub>2</sub>S, NH<sub>3</sub>, SO<sub>2</sub>, NO<sub>X</sub>, etc)

## 12. Handling of silicone resin for LEDs

- Acrich series is encapsulated with silicone resin for high optical efficiency.
- Please do not touch the silicone resin area with sharp objects such as pincette(tweezers).
- Finger prints on silicone resin area may affect the performance.
- Please store LEDs in covered containers as it is dust sensitive.
- Excessive force more than 3000gf to the silicone lens can result in fatal or permanent damage with LEDs.
- Please do not cover the silicone resin area with any other resins such as epoxy, urethane, etc.

## 13. Handling with regards to static electricity

- The Acrich2 modules use an integrated circuit (IC) which can be damaged when exposed to static electricity. Please handle using equipment that prevents static electricity. Do not touch unless ESD protection is used.
- The Acrich2 modules should also not be installed in end equipment with out ESD protection.

## 14. Storage before use

- Do not impact or place pressure on this product because even a small amount of pressure can damage the product. The product should also not be placed in high temperatures, high humidity or direct sunlight since the device is sensitive to these conditions.

(1) Please, confirm the lists below, when storing it in a long term.

- \* It should be stored in the anti-static bag that Seoul-Semiconductor packed without opening it.
- \* If you opened it in order to prevent humidity, you should seal it and not let the air and humidity into the bag.