

# Specification

**Acrich2 – Bulb**

**220V 4.3W**

**SMJE-3V04W1P3**

SSC		Customer
Drawn	Approval	Approval

## Acrich2 - 220V 4.3W Bulb

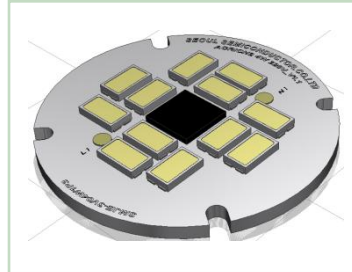

### Description

The Acrich 2 series of products are designed to be driven directly off of AC line voltage, therefore they do not need the standard converter essential for conventional general lighting products.

The converter or driver found in most general lighting products can limit the overall life of the product, but with the Acrich 2 series of products the life of the product can more closely be estimated from the LED itself.

This will also allow for a much smaller form factor from an overall fixture design allowing for higher creativity in the fixture.

The modules have a high power factor which can contribute to a higher energy savings in the end application.

\* The appearance and specifications of the product can be changed for improvement without notice.

## Acrich2

### Features

- Connects directly to AC line voltage
- High Power Efficiency
- High Power Factor
- Low THD
- Long Life Time
- Simple BOM
- Miniaturization
- Lead Free product
- RoHS compliant

### Applications

- PAR16 light
- Candle light
- Bulb light

## [ Contents ]

<b>1.</b>	<b>Characteristics -----</b>	<b>4</b>
<b>2.</b>	<b>Thermal Resistance -----</b>	<b>7</b>
<b>3.</b>	<b>Color spectrum -----</b>	<b>8</b>
<b>4.</b>	<b>Power characteristics -----</b>	<b>10</b>
<b>5.</b>	<b>Radiation pattern -----</b>	<b>11</b>
<b>6.</b>	<b>Color &amp; Binning -----</b>	<b>12</b>
<b>7.</b>	<b>Marking -----</b>	<b>15</b>
<b>8.</b>	<b>Outline dimensions -----</b>	<b>15</b>
<b>9.</b>	<b>Circuit Drawing -----</b>	<b>16</b>
<b>10.</b>	<b>Packing -----</b>	<b>17</b>
<b>11.</b>	<b>Cautions for use -----</b>	<b>18</b>
<b>12.</b>	<b>Handling of silicone resin for LEDs -----</b>	<b>18</b>
<b>13.</b>	<b>Handling with regards to static electricity --</b>	<b>19</b>
<b>14.</b>	<b>Storage before use -----</b>	<b>19</b>
<b>15.</b>	<b>Guidelines for properly working with Acrich module -----</b>	<b>19</b>

## 1. Characteristics

### 1-1-1. Electro-Optical characteristics of SMJE-3V04W1P3-B rank

Parameter	Symbol	Value			Unit
		Min	Typ	Max	
<b>Luminous Flux</b> [2]	$\Phi_v$ [3]	340	360	-	lm
<b>Correlated Color Temperature</b> [4]	CCT	5300	5600	6000	K
<b>CRI</b>	$R_a$	80	-	-	-
<b>Operating Voltage</b> [5]	$V_{opt}$	220			V[RMS]
<b>Power Dissipation</b>	$P_D$	4.0	4.3	4.6	W
<b>Operating Frequency</b>	Freq	50 / 60			Hz
<b>Power Factor</b>	PF	Over 0.95			-
<b>View Angle</b>	$2\theta$ 1/2	120			deg.

### 1-1-2. Electro-Optical characteristics of SMJE-3V04W1P3-C rank

Parameter	Symbol	Value			Unit
		Min	Typ	Max	
<b>Luminous Flux</b> [2]	$\Phi_v$ [3]	330	350	-	lm
<b>Correlated Color Temperature</b> [4]	CCT	4700	5000	5300	K
<b>CRI</b>	$R_a$	80	-	-	-
<b>Operating Voltage</b> [5]	$V_{opt}$	220			V[RMS]
<b>Power Dissipation</b>	$P_D$	4.0	4.3	4.6	W
<b>Operating Frequency</b>	Freq	50 / 60			Hz
<b>Power Factor</b>	PF	Over 0.95			-
<b>View Angle</b>	$2\theta$ 1/2	120			deg.

**1-1-3. Electro-Optical characteristics of SMJE-3V04W1P3-E rank**

Parameter	Symbol	Value			Unit
		Min	Typ	Max	
<b>Luminous Flux</b> [2]	$\Phi_v$ [3]	320	340	-	lm
<b>Correlated Color Temperature</b> [4]	CCT	3700	4000	4200	K
<b>CRI</b>	$R_a$	80	-	-	-
<b>Operating Voltage</b> [5]	$V_{opt}$	220			V[RMS]
<b>Power Dissipation</b>	$P_D$	4.0	4.3	4.6	W
<b>Operating Frequency</b>	Freq	50 / 60			Hz
<b>Power Factor</b>	PF	Over 0.95			-
<b>View Angle</b>	$2\theta$ 1/2	120			deg.

**1-1-4. Electro-Optical characteristics of SMJE-3V04W1P3-G rank**

Parameter	Symbol	Value			Unit
		Min	Typ	Max	
<b>Luminous Flux</b> [2]	$\Phi_v$ [3]	310	330	-	lm
<b>Correlated Color Temperature</b> [4]	CCT	2900	3000	3200	K
<b>CRI</b>	$R_a$	80	-	-	-
<b>Operating Voltage</b> [5]	$V_{opt}$	220			V[RMS]
<b>Power Dissipation</b>	$P_D$	4.0	4.3	4.6	W
<b>Operating Frequency</b>	Freq	50 / 60			Hz
<b>Power Factor</b>	PF	Over 0.95			-
<b>View Angle</b>	$2\theta$ 1/2	120			deg.

**1-1-5. Electro-Optical characteristics of SMJE-3V04W1P3-H rank**

Parameter	Symbol	Value			Unit
		Min	Typ	Max	
<b>Luminous Flux</b> [2]	$\Phi_V$ [3]	300	320		lm
<b>Correlated Color Temperature</b> [4]	CCT	2600	2700	2900	K
<b>CRI</b>	$R_a$	80	-	-	-
<b>Operating Voltage</b> [5]	$V_{opt}$	220			V[RMS]
<b>Power Dissipation</b>	$P_D$	4.0	4.3	4.6	W
<b>Operating Frequency</b>	Freq	50 / 60			Hz
<b>Power Factor</b>	PF	Over 0.95			-
<b>View Angle</b>	$2\theta$ 1/2	120			deg.

**1-2. Absolute Maximum Ratings**

Parameter	Symbol	Value	Unit
<b>Max. Voltage</b>	$V_{opt}$	264	V[RMS]
<b>Power Dissipation</b>	$P_d$	5.7	W
<b>Operating Temperature</b>	$T_{opr}$	-30 ~ 85	°C
<b>Storage Temperature</b>	$T_{stg}$	-40 ~ 100	°C
<b>ESD Sensitivity</b>	-	±4,000V HBM	-

\* Notes :

[1] At 120V RMS,  $T_a=25^\circ\text{C}$

[2] Acrich 2 series maintain the tolerance of  $\pm 10\%$  on flux and power measurements.

[3]  $\Phi_V$  is the total luminous flux output measured with an integrated sphere.

[4] Correlated Color Temperature is derived from the CIE 1931 Chromaticity diagram.

[5] Operating Voltage doesn't indicate the maximum voltage which customers use but means tolerable voltage according to each country's voltage variation rate.

It is recommended that the solder pad temperature should be below  $70^\circ\text{C}$ .

## 2. Thermal Resistance

Part	Package Power Dissipation [W]	Maximum Junction Temp[°C]	R $\theta_{j-s}$ [°C/W]
Acrich2 LED	SAW8KG0B Max 0.5	125	27
Acrich2 IC	Max 1.0	125	16.4

The Acrich2 LED has a thermal resistance of 27 °C/W from junction of the LED to the LED lead.

The maximum junction temperature of the Acrich2 LED package is 125 °C, therefore the maximum lead temperature T<sub>s\_max</sub> is

$$T_{s\_max} = T_{j\_max} - (R\theta_{j-s} * P_D)$$

$$= 125^{\circ}\text{C} - (27^{\circ}\text{C/W} * 0.5\text{W}) = 111.5^{\circ}\text{C}$$

Although this is the maximum lead temperature, it is recommended to keep the lead temperature under 70 °C

The Acrich2 IC has a 16.4degC/W thermal resistance from junction to the top surface.

The maximum junction temperature (T<sub>t\_max</sub>) of the IC is 125 °C, therefore the maximum temperature of the top of the IC is

$$T_{t\_max} = T_{j\_max} - (\Psi_{j-t} * P_D)$$

$$= 125^{\circ}\text{C} - (16.4^{\circ}\text{C/W} * 1.0\text{W}) = 108.6^{\circ}\text{C}$$

### 3. Color spectrum

Warm White Relative Spectral Distribution vs. Wavelength Characteristic

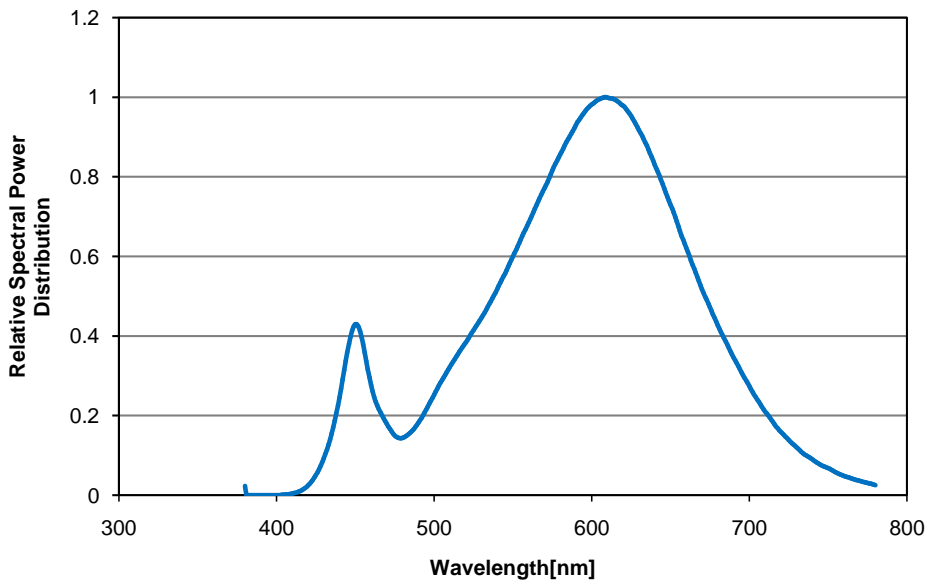

Neutral White Relative Spectral Distribution vs. Wavelength Characteristic

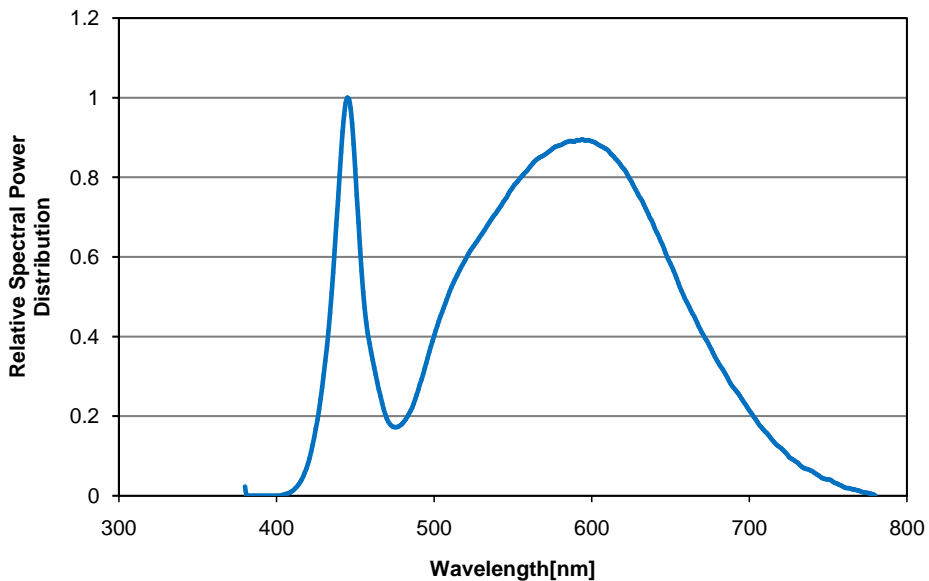



Cool White Relative Spectral Distribution vs. Wavelength Characteristic

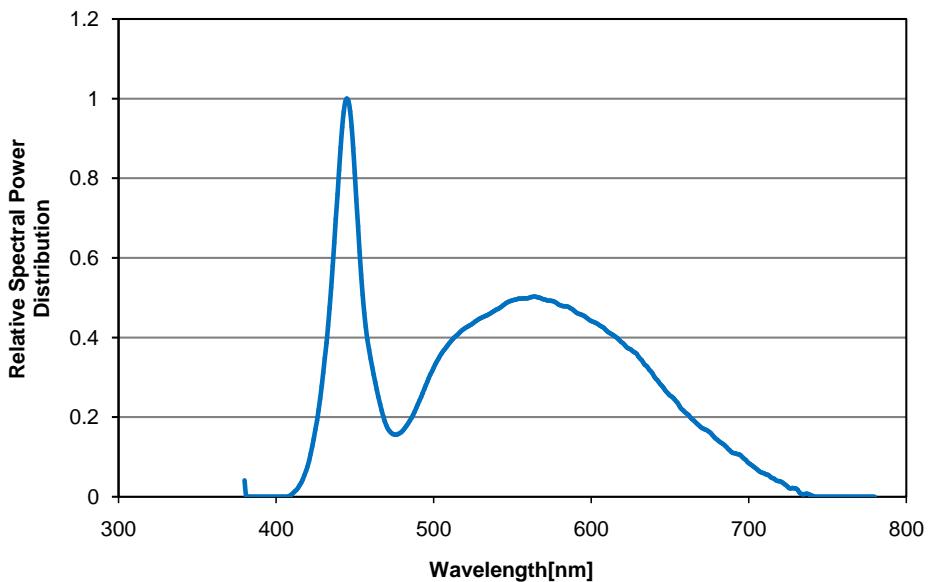

## 4. Power characteristic

Relative Power Distribution vs. Voltage at Ta=25°C

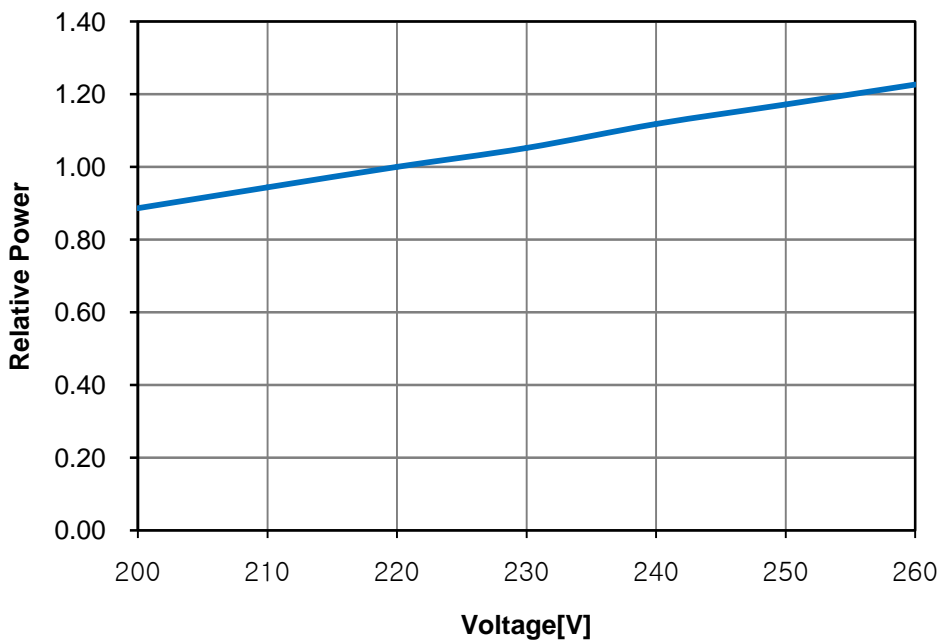

Relative Luminous flux vs. Forward Voltage, Ta= 25°C

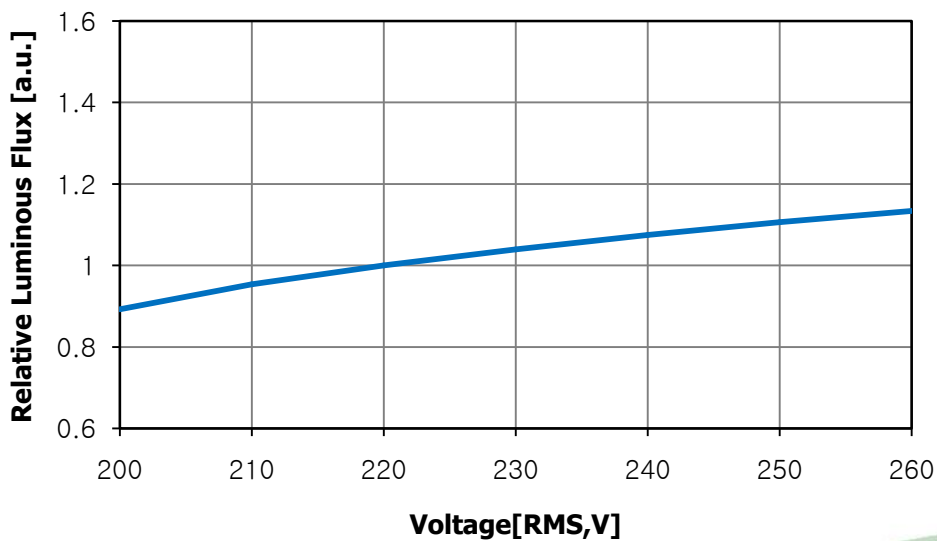

— All Color Temperatures

## 5. Radiation Pattern

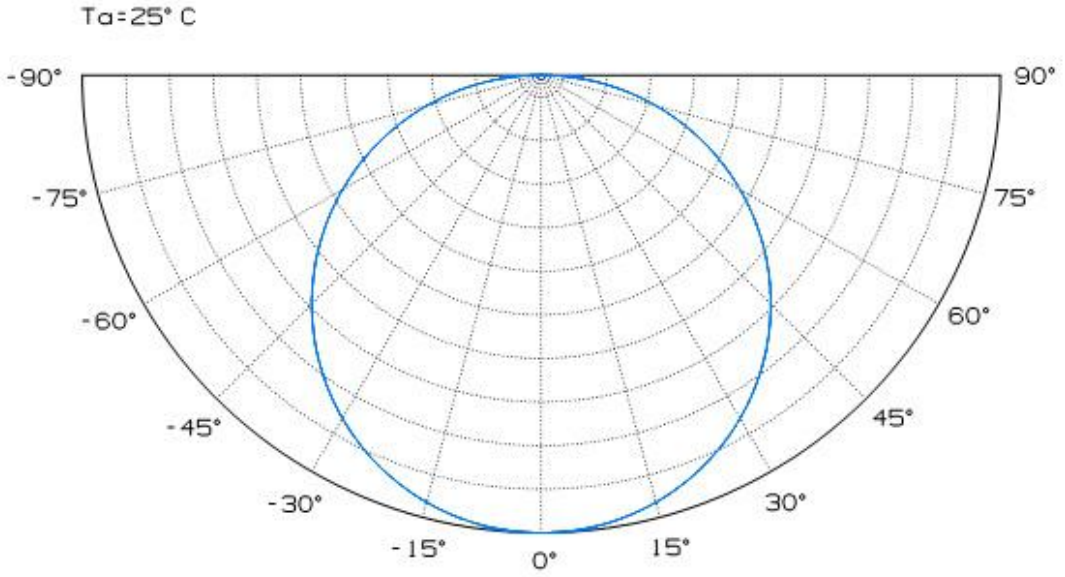

## 6. Color & Binning

### 6-1. Warm White binning structure (2,600K to 3,200K)

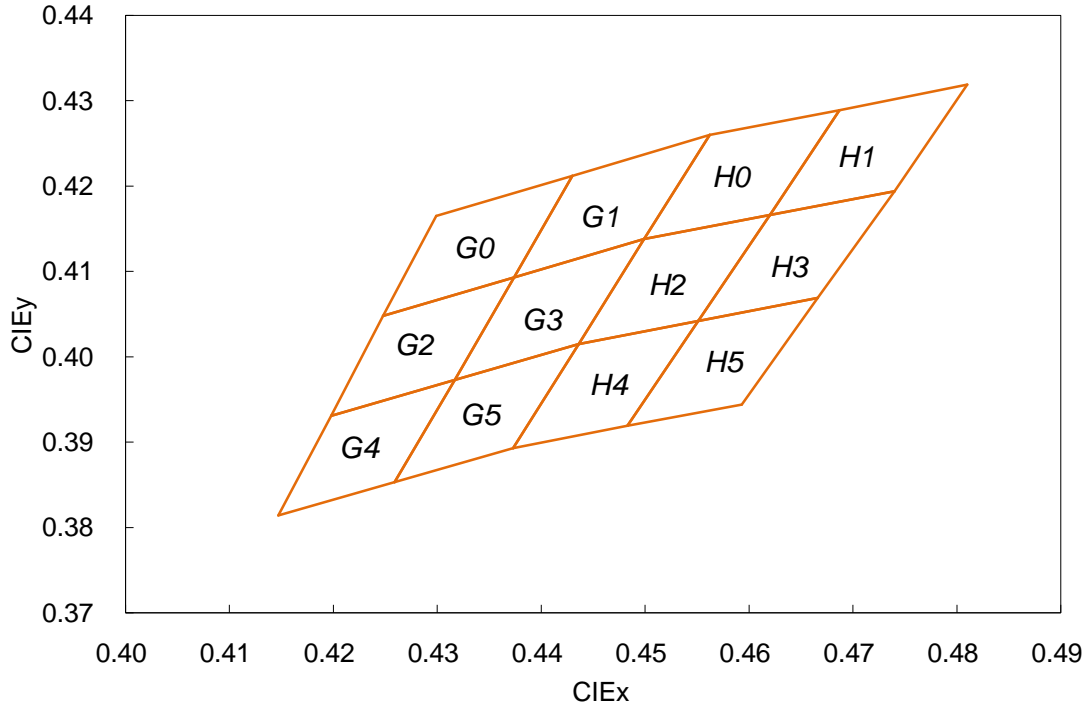

Bin code	X	Y	Bin code	X	Y	Bin code	X	Y
G0	0.4299	0.4165	G1	0.4430	0.4212	G2	0.4248	0.4048
	0.4248	0.4048		0.4374	0.4093		0.4198	0.3931
	0.4374	0.4093		0.4499	0.4138		0.4317	0.3973
	0.4430	0.4212		0.4562	0.4260		0.4374	0.4093
G3	0.4374	0.4093	G4	0.4198	0.3931	G5	0.4317	0.3973
	0.4317	0.3973		0.4147	0.3814		0.4259	0.3853
	0.4436	0.4015		0.4259	0.3853		0.4373	0.3893
	0.4499	0.4138		0.4317	0.3973		0.4436	0.4015
H0	0.4562	0.4260	H1	0.4687	0.4289	H2	0.4499	0.4138
	0.4499	0.4138		0.4620	0.4166		0.4436	0.4015
	0.4620	0.4166		0.4740	0.4194		0.4551	0.4042
	0.4687	0.4289		0.4810	0.4319		0.4620	0.4166
H3	0.4620	0.4166	H4	0.4436	0.4015	H5	0.4551	0.4042
	0.4551	0.4042		0.4373	0.3893		0.4483	0.3919
	0.4666	0.4069		0.4483	0.3919		0.4593	0.3944
	0.4740	0.4194		0.4551	0.4042		0.4666	0.4069

**6-1. Neutral White binning structure (3,700K to 4,200K)**

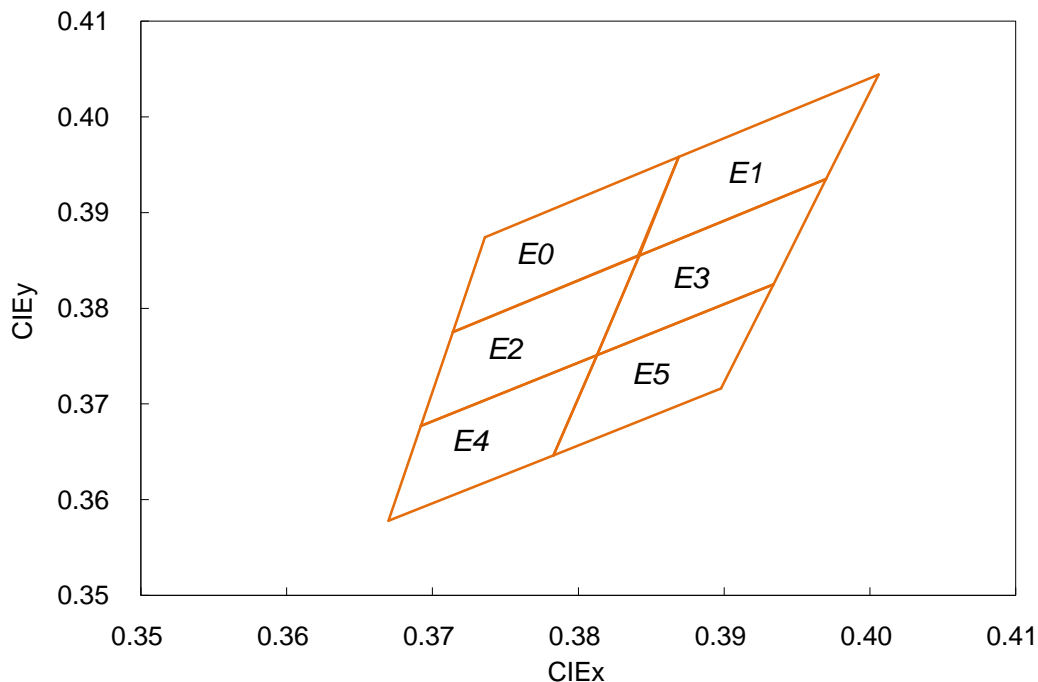

Bin code	X	Y	Bin code	X	Y	Bin code	X	Y
E0	0.3736	0.3874	E1	0.3869	0.3958	E2	0.3714	0.3775
	0.3714	0.3775		0.3842	0.3855		0.3692	0.3677
	0.3841	0.3855		0.3970	0.3935		0.3813	0.3751
	0.3869	0.3958		0.4006	0.4044		0.3842	0.3855
E3	0.3842	0.3855	E4	0.3692	0.3677	E5	0.3813	0.3751
	0.3813	0.3751		0.3670	0.3578		0.3783	0.3646
	0.3934	0.3825		0.3783	0.3646		0.3898	0.3716
	0.3970	0.3935		0.3813	0.3751		0.3934	0.3825

**6-1. Cool White binning structure (4,700K to 6,000K)**

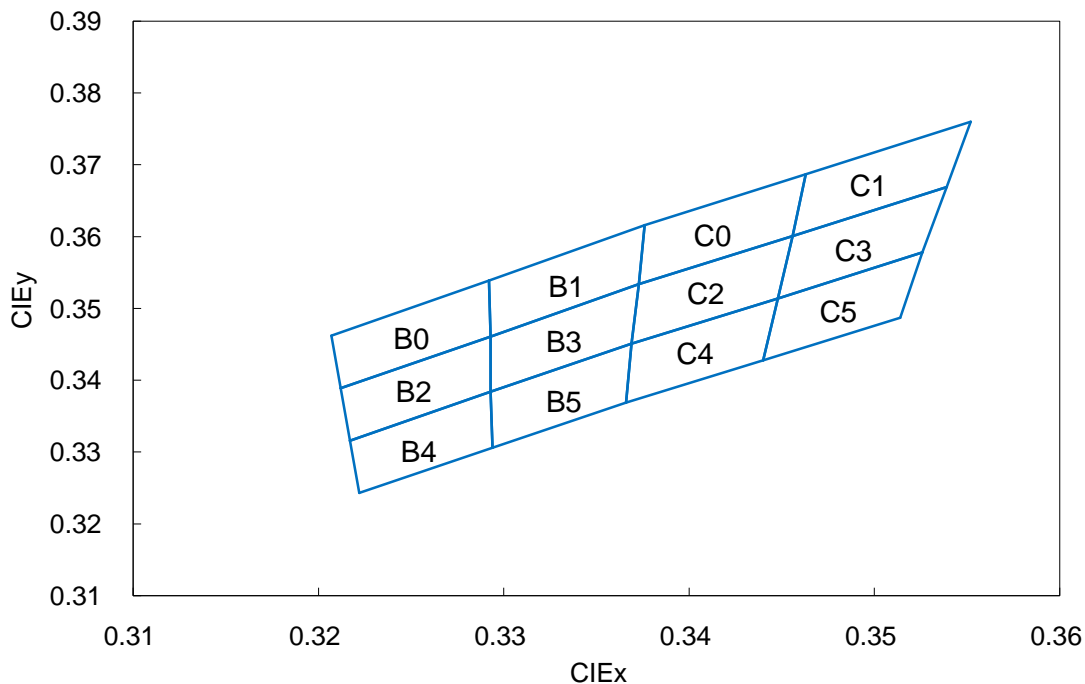

Bin code	X	Y	Bin code	X	Y	Bin code	X	Y
B0	0.3207	0.3462	B1	0.3292	0.3539	B2	0.3212	0.3389
	0.3212	0.3389		0.3293	0.3461		0.3217	0.3316
	0.3293	0.3461		0.3373	0.3534		0.3293	0.3384
	0.3292	0.3539		0.3376	0.3616		0.3293	0.3461
B3	0.3293	0.3461	B4	0.3217	0.3316	B5	0.3293	0.3384
	0.3293	0.3384		0.3222	0.3243		0.3294	0.3306
	0.3369	0.3451		0.3294	0.3306		0.3366	0.3369
	0.3373	0.3534		0.3293	0.3384		0.3369	0.3451
C0	0.3376	0.3616	C1	0.3463	0.3687	C2	0.3373	0.3534
	0.3373	0.3534		0.3456	0.3601		0.3369	0.3451
	0.3456	0.3601		0.3539	0.3669		0.3448	0.3514
	0.3463	0.3687		0.3552	0.3760		0.3456	0.3601
C3	0.3456	0.3601	C4	0.3369	0.3451	C5	0.3448	0.3514
	0.3448	0.3514		0.3366	0.3369		0.3440	0.3428
	0.3526	0.3578		0.3440	0.3428		0.3514	0.3487
	0.3539	0.3669		0.3448	0.3514		0.3526	0.3578

## 7. Marking

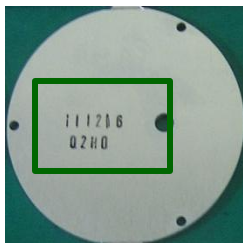

XXXXXX – Year / Month/date / Production date  
 XXXX – LED PKG Flux Rank / Color Bin Rank

## 8. Outline dimensions

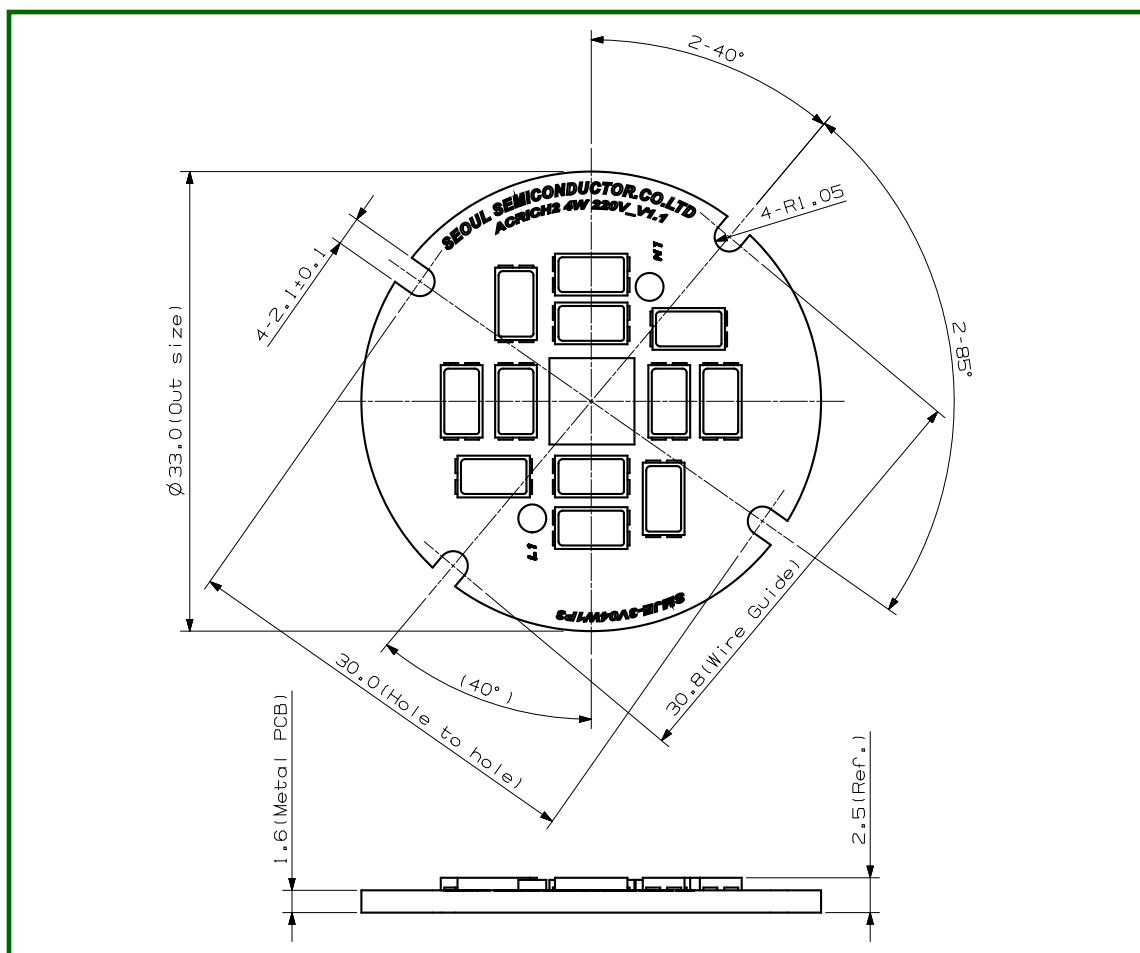

\* Notes :

- [1] All dimensions are in millimeters. (Tolerance : ±0.2)
- [2] Scale : none
- [3] The appearance and specifications of the product may be changed for improvement without notice

## 9. Circuit Drawing

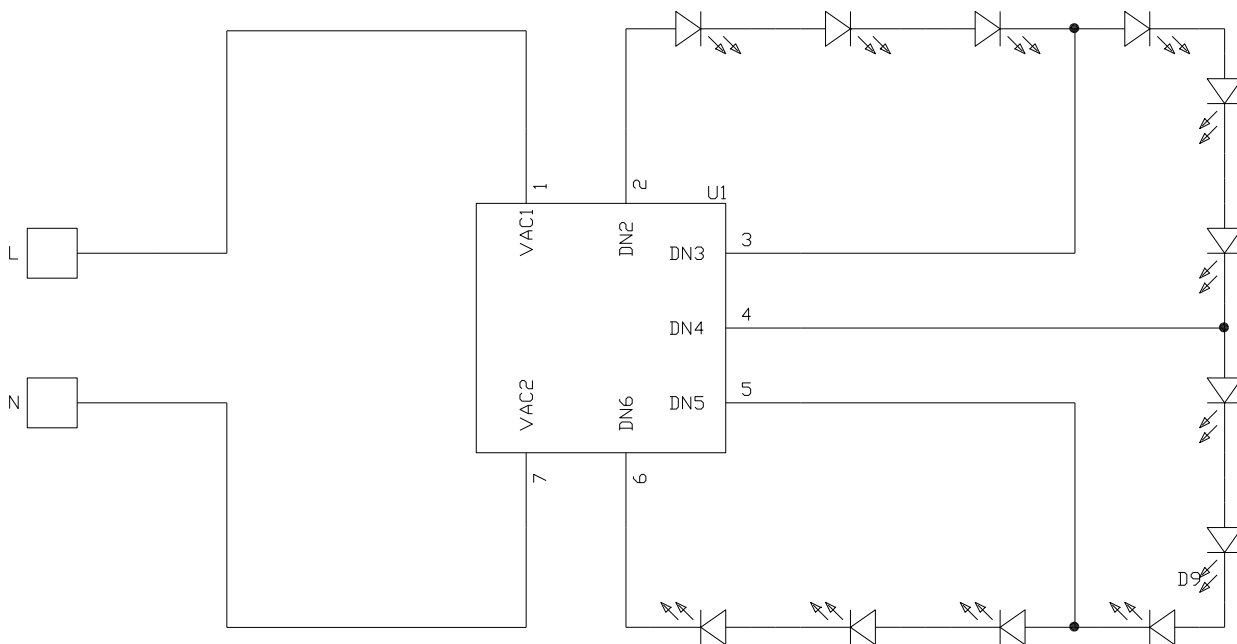



## 10. Packing

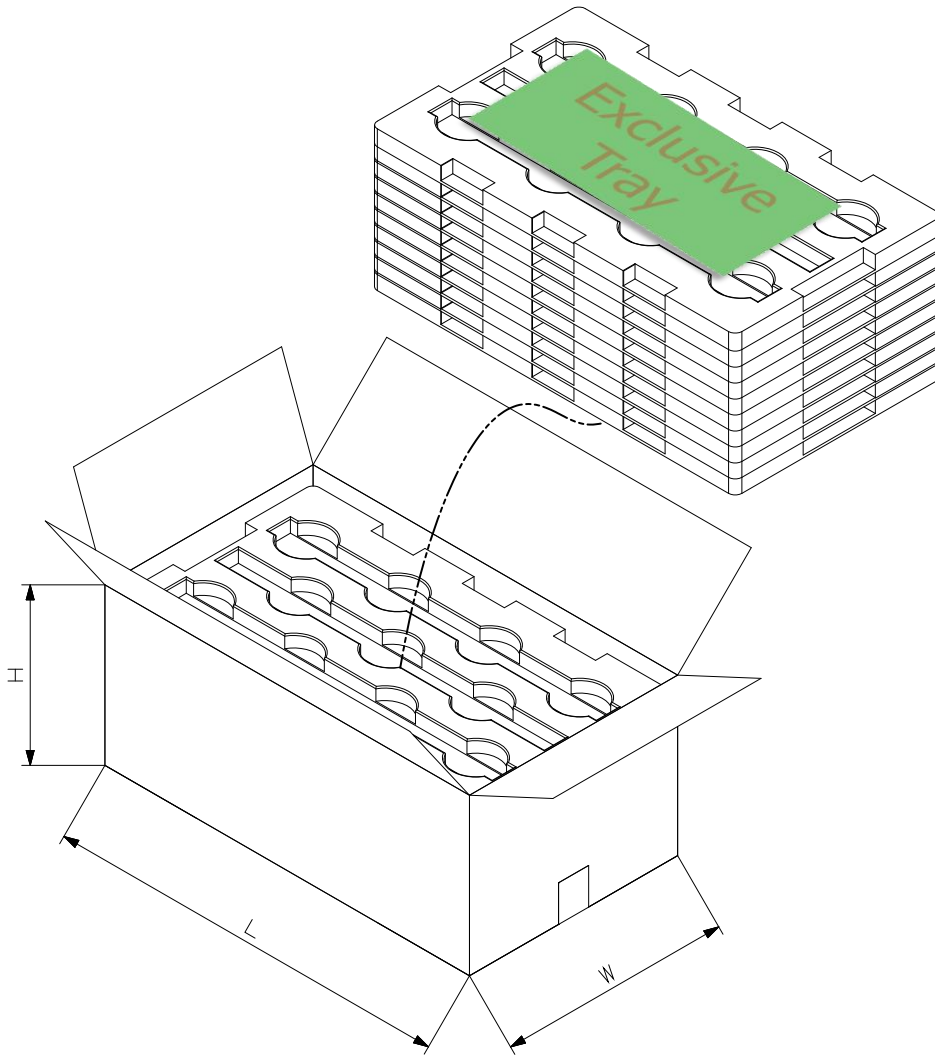

◦ **1Box : 60 PCS per tray x Max 8 layer = Max 480 PCS**

**about 5kg**

◦ **Box size( L x W x H ) = 590 x 330 x 260**

## 11. Cautions for use

- Please review the Acrich2 Module Application Note for proper protective circuitry usage
- Please note, Acrich products run off of high voltage, therefore caution should be taken when working near Acrich products.
- DO NOT touch any of the circuit board, components or terminals with body or metal while circuit is active.
- Please do not add or change wires while Acrich circuit is active
- Long time exposure to sunlight or UV can cause the lens to discolor.
- Please do not use adhesives to attach the LED that outgas organic vapor.
- Please do not use together with the materials containing Sulfur.
- Please do not assemble in conditions of high moisture and/or oxidizing gas such as Cl, H<sub>2</sub>S, NH<sub>3</sub>, SO<sub>2</sub>, NO<sub>x</sub>, etc.
- Please do not make any modification on module.
- Please be cautious when soldering to board so as not to create a short between different trace patterns.

## 12. Handling of silicone resin for LEDs

- Acrich series is encapsulated with silicone resin for high optical efficiency.
- Please do not touch the silicone resin area with sharp objects such as pincette(tweezers).
- Finger prints on silicone resin area may affect the performance.
- Please store LEDs in covered containers to prevent dust accumulation as this may affect performance.
- Excessive force more than 3000gf to the silicone lens can result in fatal or permanent damage with LEDs.
- Please do not cover the silicone resin area with any other resins such as epoxy, urethane, etc.

### 13. Handling with regards to static electricity

- The Acrich2 modules use an integrated circuit (IC) which can be damaged when exposed to static electricity. Please handle using equipment that prevents static electricity. Do not touch unless ESD protection is used.
- The Acrich2 modules should also not be installed in end equipment with out ESD protection.

### 14. Storage before use

- Do not impact or place pressure on this product because even a small amount of pressure can damage the product. The product should also not be placed in high temperatures, high humidity or direct sunlight since the device is sensitive to these conditions.

(1) When storing devices for a long period of time before usage, please following these guidelines:

- \* The devices should be stored in the anti-static bag that it was shipped in from Seoul-Semiconductor with opening.
- \* If the anti-static bag has been opened, re-seal preventing air and moisture from being present in the bag.

### 15. Guidelines for properly working with Acrich modules.

- Discharge the lighting system a minimum of 2-3 times prior to working with the module.
- Use only properly rated test equipment and tools for the rated voltage and current of the product being tested.
- It is strongly suggested to wear rubber insulated gloves and rubber bottom shoes.
- Do not wear any conductive items (such as jewelry) which could accidentally contact electric circuits.
- Perform several tests with power off and the lighting system unplugged.
- Faults, lightning, or switching transients can cause voltage surges in excess of the normal ratings.
- Internal component failure can cause excessive voltages.
- Stored or residual electricity in long wire could be hazardous.
- Make sure proper discharge prior to starting work.